



Desktop Planning Assessment Report

Frank Walmsley
14 Macnamara Place, Chisholm ACT 2905
Completed on 27th April 2023

Frank,

Thank you for the opportunity to provide you a Planning Assessment Report for your property at **14 Macnamara Place, Chisholm ACT 2905.**

The purpose of this report is to provide you with a written assessment of the likelihood of obtaining a development/building approval for a Secondary Residence or Fixed Price Extension on your property (in the ACT).

We will ideally step through this report online via Zoom or MSTEAMS, or face to face in our Canberra office. If you have received this via email and have questions, please email or call me.

We note that you may only be investigating the planning parameters regarding an extension now, however, to provide you all practical options we have provided a Planning Assessment that encompasses for both extensions and Secondary Residences in the event you change your objectives during the process.

We have addressed the planning considerations and requirements under the:

- **Building Act (2004) and National Construction Code**
- **Territory Plan (2008)**
- **Planning and Development Act (2007) and Single Dwelling Housing Development Code**
- **Tree Protection (2005) and Utilities Act (2000)**

Within this report we have provided:

- An overview of the relevant legislation that impacts on the design, planning, approval and construction of your Secondary Residence, or an extension.
- The conditions that will need to be met to achieve Development Approval for a Secondary Residence or extension. On your block. This is what we call the **Planning Assessment Conclusion**, which should be read in conjunction with the **Planning Assessment Considerations**.
- We have undertaken a search of key utilities and infrastructure to determine future impacts as it relates to building and or development applications.
- Advice in the question-and-answer section which address elements we believe relate to your property, based on our experience with previous projects and customers.

This will form the agenda of our Planning Assessment meeting, in which we will also discuss most suitable design for your needs and block, project timelines and value/budget considerations and the most suited designs.

Kind regards



Frank Walmsley – Client Services Manager
0400446605 – clientservices@cgfb.com.au

Table of Contents

Desktop Planning Assessment Report.....	1
Table of Contents.....	3
Client Overview.....	4
Planning and Regulation Overview.....	6
Key concepts and planning elements.....	7
Planning Assessment Conclusion for your Property if building a Secondary Residence	16
Next Stages– Design Process Secondary Residence and Fixed Price Extension.....	18
Attachment A: Questions and Answers about Secondary Residences	20
Diagrams that will help us understand the planning pathways and potential issues.....	22
Example plans that we will create during the custom and modification design process.....	35
What happens next?.....	61

Client Overview

Client	Frank Walmsley
Client Address	TBC
Project Address	14 Macnamara Place, Chisholm ACT 2905
Property Type	Owner Occupier / Investment Property
Block Number	37
Section Number	16
Suburb/Division	Chisholm
Land Use Zone	RZ1: SUBURBAN
Housing Code	TBC
Suburb Precinct Code	https://www.legislation.act.gov.au/DownloadFile/ni/2008-27/copy/90130/PDF/2008-27.PDF
District Precinct Code	https://www.legislation.act.gov.au/DownloadFile/ni/2008-27/copy/96479/PDF/2008-27.PDF
ACTMapi Link	https://app.actmapi.act.gov.au/actmapi/index.html?viewer=basic
Pricefinder Link	https://app.pricefinder.com.au/v4/app?page=property/PropertyLink&service=external&action=property&propertyid=12772059
Block Size and Approval	934m ²
When the block was approved	TBC
Block Type	Large Block
Plot Ratio rule for the block type	50% *driveway included for battle-axe block calculations
Site Coverage rule for the block	40%

Easements	<p>Electrical Easement Position – South West Boundary Size – 2.91 meter wide from Boundary</p> <p>Stormwater Easement Position – South West Boundary Size – 2.91 meter wide from Boundary</p>
Location of Switchboard	TBC
Above/Below Ground Power	TBC
Heritage Status	N/A
Protected, registered or regulated trees	Yes
Lease Purpose	Single Residential Dwelling
Unimproved Value	\$502,000 for (2022/2023)
Rates	\$2,775 for (2022/2023)
Land Tax	\$4,222 for (2022/2023)
Settlement date Relevant for ICON works form	07/07/1997
Who Created	Sachin 27/04/2023

Planning and Regulation Overview

Why understanding the planning approvals process is so important

At Canberra Granny Flat Builders and Fixed Price Extensions we are accountable for the management and delivery for all stages of your project including initial design, inclusions, planning approvals and building.

We employ specialist teams dedicated to ensuring that your design obtains all required planning approvals to commence building as efficiently as possible.

We manage the entire process from end to end and we are accountable with our time, quality, and price guarantees.

On a yearly basis we assist 100 families and clients across Canberra manage their designs, planning approvals.

In terms of these planning approvals, there are two main pathways that a residential building project/development can follow in Canberra.

In its most simple terms projects either require both **development and building approval** or just **building approval**. All Secondary Residences require development approval.

Extensions are often exempt from development approval, if they meet all relevant planning requirements, which will be discussed in more detail below.

Regardless of whether a project requires a development approval, all designs will require building approval, which is an assessment and clearance of the design completed by a private building certifier.

In the ACT, the most significant planning document is the *Territory Plan 2008*, and it contains the bulk of the regulations which this project would need to be compliant with.

The most relevant of these regulations is the *Single Dwelling Housing Development Code* (SDHDC), contained within Section 3 of the Plan.

Key concepts and planning elements

Rules and criteria, the difference, and how this impacts the planning approvals process

The most significant code we refer to for clients considering a Secondary Residence or an extension is the **Single Dwelling Housing Development Code (SDHDC)**

Under the SDHDC, there are many rules that a project must comply with to be compliant under ACT planning law. However, there is recognition that these rules can often be too restrictive or can unreasonably inhibit the best utilisation of the block.

This is where criteria become relevant.

Criteria is attached to rules to be used in instances where they are breached, to be used to show that whilst your project may not meet the rule as written, it matches the intent of the rule. It is important to note not all rules have these, but many of the core rules do.

Below is an example of rule and criteria, in this case applicable to side and rear setbacks. You can see the rule visible on the left, and the criteria listed on the right. A straightforward way to distinguish rule and criteria is how they are labelled, with rules always labelled R#, and Criteria always labelled C#.

<p>R12</p> <p>This rule applies to one of the following:</p> <ul style="list-style-type: none"> i) <i>standard blocks</i> that are not part of an <i>integrated housing development parcel</i> ii) <i>standard blocks</i> in an <i>integrated housing development parcel</i> that adjoin <i>residential blocks</i> that are not part of that parcel. <p>Side and rear setbacks for:</p> <ul style="list-style-type: none"> a) <i>large blocks</i> - comply with table 5 b) <i>mid-sized blocks</i> - comply with tables 6A or 6B, as applicable c) <i>mid-sized blocks</i> nominated for alternative side boundary setbacks in a precinct code - comply with table 6C d) <i>compact blocks</i> - comply with table 7. <p>In relation to the tables referred to in this rule, side boundary 1 and side boundary 2 are nominated by the applicant unless otherwise specified in this code or in a precinct code</p> <p>Note: Ordinarily a corner <i>block</i> has two <i>front boundaries</i>, one of which is the secondary frontage, two <i>side boundaries</i>, but no rear boundary.</p>	<p>C12</p> <p>Buildings and other structures are sited to achieve all of the following:</p> <ul style="list-style-type: none"> a) consistency with the <i>desired character</i> b) reasonable separation between adjoining developments c) reasonable privacy for <i>dwellings</i> on adjoining <i>residential blocks</i> d) reasonable privacy for <i>principal private open space</i> on adjoining <i>residential blocks</i> e) reasonable solar access to <i>dwellings</i> on adjoining <i>residential blocks</i> and their associated <i>principal private open space</i>.
--	--

Below is an example of a rule which has no applicable criteria, meaning it must be met or the project will be viewed as non-compliant with ACT planning law.

<p>R2</p> <p>The number of <i>storeys</i> does not exceed:</p> <p>a) in RZ1, RZ2 and RZ3 – 2</p> <p>b) in RZ4 – 3.</p> <p>Rooftop plant that is set back and screened from the street is not included in the maximum number of storeys.</p>	<p>This is a mandatory requirement. There is no applicable criterion.</p>
---	---

The final aspect to keep in mind related to criteria is who can judge whether a design has met it. Whilst ACTPLA and Certifiers in the ACT are both arbiters of planning approval law, only ACTPLA can make judgements regarding whether a design has met criteria. This means that if your design breaches a rule and requires the use of criteria to be approved, you will need to make some form of application with ACTPLA, whether that be an application for exemption, or a full development application (DA).

Exempt Declarations

Referred to technically as 1N Applications, an exemption declaration can be sought for minor reaches of particular rules under the SDHDC. An exemption allows for the project to avoid a full development approval process, as long as the rule breach is minor in nature. Only a strict number of rules are eligible for these applications, these being:

- Front, side or rear setbacks
- Building or solar envelopes
- Courtyard wall setbacks
- Minimum dimension of Private Open Space

In its decision, ACTPLA will only approve an exemption if the non-compliance is minor, has no adverse effects on anyone other than the lessee of the block, and does not increase the environmental impact of the structure adversely.

If an exemption is received for a rule breach, this can allow for the project to resume a straight building approval process but if denied will mean that a development application will be required.

It is important to note that an exemption declaration being rejected does not mean the project would fail a DA, it just means that ACTPLA did not view the rule breach minor enough to warrant an exemption.

Plot Ratio – this is an important concept for you to understand

Plot ratio dictates the level to which you can build up your block. It is calculated by taking the percentage of your home/proposed design and the total size of your block. Most of the blocks on which we build must have a plot ratio equal to or below 50% (as per Element 1: Building and Site Controls, R1).

In this Planning Assessment meeting we will discuss the applicable Plot Ratio rule that applies to your block.

Applicable Boundary Setbacks – breaches of setbacks often trigger development applications

A setback is the distance in which a building or other structure must be positioned from a street, road, or any other place deemed to require a separation.

In the ACT, residential zones require setbacks from the property boundary, referred to as 'Front Street setbacks', 'side setbacks' and 'rear setbacks'.

The size of the setback required will depend on the size classification and the approval date of the block. If we have determined that your land is located on a 'Large Block' according to Definitions under Section 13 of the Territory Plan, the below rules will apply.

Setbacks for the block are defined in Element 1 of the Single Dwelling Housing Development Code:

	Minimum Front Boundary Setback	Exceptions	
		Minimum Front Boundary Setback to Secondary Street Frontage	Minimum Front Boundary Setback to Open Space or Pedestrian Paths Wider Than 6m
Lower Floor Level	6m	4m	4m
Upper Floor Level	6m	6m	4m
Garage	6m	5.5m	4m

	Minimum Side Boundary Setback Within the Primary Building Zone		Minimum Side Boundary Setback Within the Rear Zone		Minimum Rear Boundary Setback
	Side Boundary 1	Side Boundary 2	Side Boundary 1	Side Boundary 2	
Lower Floor Level – External Wall	3m	1.5m	3m	1.5m	3m
Upper Floor Level – External Wall	3m	3m	6m	6m	6m
Upper Floor Level – Unscreened Element	6m	6m	6m	6m	6m
Garage or Carport	3m	Nil*	3m	Nil*	3m

* Wall cannot be longer than 8m, and cannot have windows

The setbacks can occasionally vary based on the date in which your block was originally approved/granted a crown lease, but our team will be able to assist you with this.

Building Within a Boundary Setback

Certain encroachments are permitted into front street setbacks, side setbacks and rear setbacks. The SDHDC provides exceptions for common encroachments, which include roof overhang with a horizontal width under 600mm, gutters, downpipes, fascia, light fittings, and landings which are less than 1m above the finished ground level.

Where clear exemptions are not granted, there is criteria attached to each rule that can be used to allow for the encroachment to still be found compliant. These criteria largely relate to privacy and amenity for pedestrians and neighbouring blocks.

If your design does breach a setback, our design team will work with you to ensure this design meets the relevant criteria so that it can pass through the planning approvals process with ease.

Any assessment based on criteria must sought through a development application.

Building Envelope and Solar Building Envelope

Alongside setback rules, the location of your project can be affected by Building Envelope and Solar Building Envelope rules.

The Building Envelope is defined by planes that are projected over your block from your boundary, beginning at 3.5m high. A diagram from the SDHDC is included at the end of this section to help visualise this rule.

Your design, under these rules, is not allowed to extend beyond these envelopes. There are a few exceptions to this rule, including flues, chimneys, antennae, aerials, and heating and cooling appliances. The rule is designed primarily to protect the privacy of adjoining blocks, as well as ensure residential developments are not excessive in terms of size.

The Solar Building Envelope rules act in a similar manner to the Building Envelope rules, but instead have a focus on solar access and shading of neighbouring blocks.

This envelope is applied to all north facing boundaries of adjoining residential blocks. As the rule deals with solar access, the height of the solar fence (the height from which the envelope is drawn) and the angle of this envelope are highly variable, and are influenced by the bearing of the boundary and position on your block.

The solar fence is typically a height of either 1.8m or 2.4m, and are drawn at angles ranging from 31 degrees to 39 degrees.

The rules for both these building envelopes, like the setback rules, have criteria attached to be used in the case when a design breaches these regulations. Our team can assist you with ensuring your design meets these criteria if it is necessary to breach these rules.

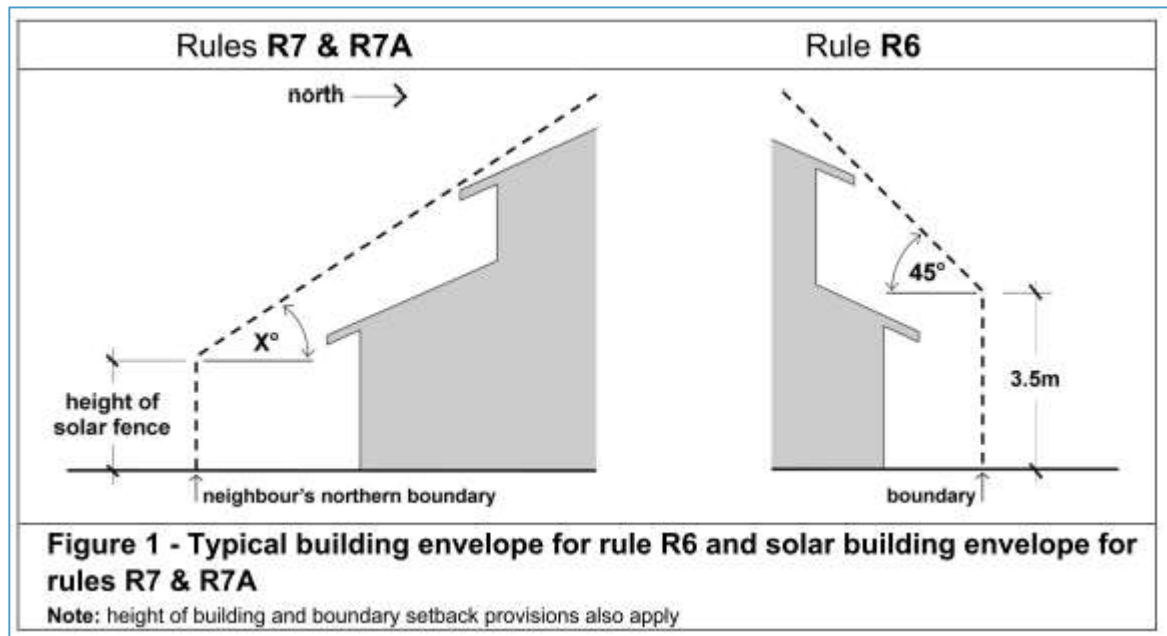

Private Open Space

Private Open Space, or POS, is the area of your block that can be used for outdoor living activities, and can include balconies, terraces, or decks. Areas that are designated for parking or for the manoeuvring of cars are excluded. The minimum POS requirement is defined under Element 5 of the SDHDC.

For *large blocks* approved before 2020, POS needs to comply with the following:

- a minimum area equal to 60% of the block area; and
- a minimum dimension of 6m for an area not less than 10% of the block.

If your proposed design breaches these rules, there are attached criteria that we can assist you with to ensure you can still receive approval for your project. These criteria largely relate to ensuring efficient use of the block and maintaining a reasonable level of outdoor use for those living there, and protection and maintaining of the natural environment.

Principal Private Open Space

Principal Private Open Space, like Private Open Space above it, is an area that is used for outdoor living activities. It differs from the above in that it is a specific area of the block that must be designated on plans, regardless of whether your design would require a development approval or building approval. This area must reach a minimum size and minimum dimension.

Zone	Block Type	Dwelling Size	Minimum Area	Minimum Dimension
All	Compact	All	16m ²	4m
RZ1 RZ2	Mid sized Large	Up to 105m ²	28m ²	4m
	Mid sized	105m ² or greater	36m ²	6m

	Large			
RZ3	Mid sized	All	24m ²	4m
RZ4	Large			

The minimum dimension must be highlighted as a square, with the minimum dimension being the length of the square’s sides.

Planting Area – new rules as of September 2022

The rules regarding planting area sit within the rules concerning private open space. For most blocks approved before 2020, a minimum of 30% of the block area must be planting area, with a minimum dimension of 2.5m.

Planting area is defined under the Territory Plan as area of the block that is available for planting and landscaping that is not covered by buildings, structures, parking areas, or any other non-permeable surface.

Tree Planting – new rules as of September 2022

One of the newest rules in the SDHDC relates tree planting in what is termed deep soil zones on the block. Deep soil zone is defined as an area of soil within a block that is unimpeded by buildings or structures above or below ground.

This rule requires that a certain number of trees with a projected size once mature are planted in these zones. Most blocks we work on require at minimum two trees, one small and one medium. Tree sizes are defined in the table below.

Tree size	Mature height	Minimum canopy	Minimum soil surface area	Minimum pot size	Minimum soil volume
Small Tree	5-8m	4m	3m	45L	18m ³
Medium Tree	8-12m	6m	5m	75L	42m ³
Large Tree	>12m	8m	7m	75L	85m ³

If your block doesn’t contain trees that are either meet these minimum requirements already, or doesn’t have trees that will grow to meet this minimum, then new trees must be planted in order for your block to be viewed as compliant with planning law.

Site Coverage - Single Dwelling Housing Development Code – new rule as of September 2022

Site coverage was introduced alongside the tree planting regulations discussed above. The site coverage rules dictate how much of your block can be built up.

Site coverage is defined as the proportion of the actual site that is covered by buildings and structures, including roofed terraces, pergolas, decks and balconies, but excludes awnings and eaves. On large blocks, maximum site coverage is 40%, but there is criteria that can be used if a design were to tip a block over this percentage.

Existing Residence Car Parking

The existing dwelling is required to provide car spaces in compliance with the *Single Dwelling Housing Development Code*.

Element 4 of the code outlines the parking rules that apply to all residential blocks, even blocks without Secondary Residences. These requirements include:

- two car parking spaces must be provided on the site;
- driveway and kerb-crossing requirements;
- car parks are not permitted in the front zone and are not permitted on verges; and
- Sightlines for off-street parking as defined in *Australian Standard AS2890.1 - Parking facilities*.

Secondary Residence Car Parking – only applies if you are building a Second Dwelling

At least 1 additional car parking space is required for a Secondary Residence that is not included in the front zone of the property as defined in the *Residential Zones Development Code* (Element 4 Secondary Residences, 4.3 parking).

Car parking on the block will be adequate for current and future residents and visitors.

Car parking and related access on the block achieve all of the following:

- reasonable amenity of neighbouring residential blocks;
- consistency with the value of the streetscape;
- public safety, especially in relation to pedestrians and cyclists; and
- Reasonable surveillance of parking spaces.

Separation of Elements

Under the *Single Dwelling Housing Development Code*, certain elements of the Secondary Residence need to be separated by a required distance. For example:

- unscreened elements need to be separated from external walls by at least 3m; and
- External walls need to be separated from other external walls by at least 1m.

Water Sensitive Urban Design

Under Element 6 of the *Single Dwelling Housing Development Code*, the block needs to be able to meet the water requirements under Rule 43. Two options are provided for each size block. One of these options must be met by the design of the Secondary Residence. This block is classified as a 'Large Block'.

Option A

For Large Blocks < 800m²:

- a) minimum on site water storage of water from roof harvesting is 4,000 litres; and/or
- b) 50% or 100m² of roof plan area, whichever is the lesser, is connected to the tank and the tank is connected to at least a toilet, laundry cold water and all external taps.

For Large Blocks > 800m²

- a) minimum on site water storage of water from roof harvesting is 5,000 litres; and/or

- b) 50% or 125m² of roof plan area, whichever is the lesser, is connected to the tank and the tank is connected to at least a toilet, laundry cold water and all external taps.

Option B for all sized blocks

A greywater system which captures all bathroom and laundry greywater and treats it to Class A standard can be provided. The treated greywater is connected to all laundry cold water, toilet flushing and all external taps.

The additional roof plan area provided by the Secondary Residence can be designed in a way to meet one of these options.

Existing infrastructure on the block can also be considered.

Evidence is provided that the development achieves a minimum 40% reduction in mains water consumption compared to an equivalent development constructed in 2003, using the ACTPLA on-line assessment tool or another tool. The 40% target is met without any reliance on landscaping measures to reduce consumption.

Precinct Codes

Part 10 of the Territory Plan provides a precinct code and precinct map for each suburb in the ACT. Precinct codes may require the development plans to meet additional restrictions, such as those concerning residential density or the building envelope.

Tree Protection

Certain trees are defined as protected, registered or regulated trees under the *Tree Protection Act 2005*. If development requires groundwork within the tree protection zone of a protected tree, then the development approval must be referred to the Conservator of Flora and Fauna. ACTPLA must consider the advice of the Conservator under the *Planning and Development Act 2007*.

Easements

Service easements are subject to the *Utilities Act 2000*.

This Act allows the Authority which controls the asset to apply additional controls to protect the asset zone, as they require. Access needs to be maintained to easements and may be adjusted by the Authority.

We have included the easements which are currently available through the ACT Planning and Land Authority's (ACTPLA) online resources.

Easements have been identified using an aerial view of your property. Any changes to the easement conditions or positions are not readily available without further written application.

Access to easements can range from approximately 1.5m to 3.5m wide and up to approximately 2.7m high.

Heritage

The *Heritage Act 2004* applies to land containing places or objects registered or provisionally registered under section 41. This will require the development application to be referred to the Heritage Council, which would provide advice to ACTPLA before they determine the application.

In this case, no heritage conditions apply to the property as viewed on the ACT Heritage Register.

Bushfire Zoning

Certain blocks of land are identified in a precinct code or current and approved *lease and development conditions* as being within a bushfire prone area. If buildings are to be constructed in a bushfire zone area, they must conform to the specified bushfire construction level of *Australian Standard AS 3959 - Construction of buildings in bushfire prone areas*.

Follow up information

In our Planning Assessment meeting we will discuss the planning approvals pathway and potential planning issues that might prevail on your specific block. If the meeting is held online, we will likely provide detailed meeting minutes.

Regardless if your meeting was online or face to face if you have follow up questions please email them through to info@cgfb.com.au or call me on 0400 446 605

Planning Assessment Conclusion for your Property if building a Secondary Residence

We note that you may be considering an extension to your property and do not require the planning assessment viability of a Secondary Residence. We have as a courtesy provide our assessment on the likelihood of approval if you change approach and decide to pursue the design and building of a Secondary Residence.

At this point in time, it is our conclusion that there is a 95% probability of building a compliant Secondary Residence if we are co-ordinate and are accountable for design and planning process, considering the considerations outlined below.

This is based on the applicable legislation that applies at the time of preparing this report.

Planning Assessment Considerations to be considered

The following considerations are noted to help meet your desired budget and outcome as well as comply with the planning and approval requirements.

Secondary Residence

- Providing at least 3 parking spaces behind the front of the building line with the ability to provide a future accessible path of travel with a maximum gradient of 1:14 to the new Secondary Residence and the street frontage/letterbox
- Provide an accessible entry and access to the essential features of the new Secondary Residence, including a bathroom, kitchen, bedroom and living spaces, meeting the criteria of AS 4299 Accessible Housing Design
- A Secondary Residence can only be approved on Single Dwelling Residential blocks

Boundary Setbacks

- Building within a side or rear setback to achieve the objectives of the project, considering the criteria including, solar access, privacy, separation, and amenity of neighbouring blocks
- Maintaining access for maintenance and reasonable separation between neighboring blocks when planning to build within 900mm of a side or rear setback

Plot Ratio and Private Open Space

- Meeting the requirements for private open space and principle private open space on the block, ensuring adequate outdoor areas are retained for outdoor activities and clothes drying, with adequate sun access, including adequate principle private open space, screened from public streets, public open space and pedestrian or cycle paths
- Meeting the requirements for plot ratio on the block to ensure the maximum allowable ratio is not exceeded which is 50%

Privacy and Separation

- Maintaining separation and a reasonable outlook between residences on the same block and adjoining blocks to allow for access, maintenance a positive aesthetic view from windows and other unscreened elements
- Designing, approving, and building appropriately fire rated separation between dwellings as required in the Building Code of Australia. Includes additional fire rated design and materials when building within 900mm of a boundary, as well as when building within 1.8m of another dwelling on the same block or an adjoining block

Parking and Driveways

- Ensuring that there is at least two parking spaces on the block and that one of them is roofed

Protected Tree

- If a tree meets the criteria stated in the *Tree Protection Act 2005*, any construction near it will require approval from the Tree Protection Unit. Removal of the tree will also require approval.

Easements

- Potential removal of existing infrastructure/vegetation built within easements may be a requirement to obtain Development and Building Approval
- Potential removal of any existing infrastructure/vegetation to improve access to easements on the property as required by planning regulations
- Providing access to an easement through a garage or carport, complying with the height and width requirements for access to easements
- Providing access to an easement through a side/front/rear boundary, complying with the height and width requirements for access to easements
- Access and protection of easements needs to be maintained and may be adjusted by the authority in control of the easement as required by way of the Utilities Act 2000
- Easements on the block have been included as currently shown on available online databases. Additional easements may be present on the block that may available through further investigation

Lease and Development Conditions

- There are lease and development conditions that apply to this block. Any non-compliance with the Conditions will require DA approval.

Heritage

- This block has a heritage precinct code that applies. Any application for development will require referral to the Heritage Council for approval.

Next Stages– Design Process Secondary Residence and Fixed Price Extension

Now that we have confirmation that you can build an extension or Secondary Residence, the steps taken next are set out below.

Stage 1: Create your unique concept plans

During this process you will meet and work with our in-house Customer Designers to create a concept design for your proposed project,

We will consider your stated objectives and any planning considerations identified.

At the conclusion of this process, you will have a set of the following:

- A set of plans they would allow our business to lodge for development application or achieve building approval in the most efficient manner with a minimum of fuss
- Floorplans with dimensions of what we propose to build.
- a rendered snapshot with a concept of what your design will look like when completed; and elevation plans with solar analysis

Please refer to the examples provided at Attachment B.

Once you have agreed on the plans, we will provide you with a fixed price total agreement to deliver the project with estimated timelines.

The total value will include the planning and development costs, the connection of services, and the total build price. We call this the turnkey price, and it means there are no hidden fees and charges.

The average/expected duration of the design process is up to 12 weeks for a Secondary Residence and 16 weeks for a more complicated extension concept.

We plan to have the initial design meeting at your home with you within the 15 working days from receiving your signed Design Agreement. If you are based overseas or interstate this initial meeting can be conducted on MSTEAMS.

A follow up meeting will be planned for 14 days after the initial meeting to discuss the first concept design.

Creating your ideal design. There are three options for you, should you decide to continue with the process of designing and pricing your Secondary Residence or fixed price extension project with our team at CGFB.

1. **Modify an existing CGFB design*** for an investment of **\$2250 inc GST**, which includes minor changes to the layout, but not the footprint of our existing design. This option has a limit of 2 minor changes. You will receive a detailed price and quality Project Proposal package once all minor changes have been completed.
2. **Create your own unique design*** for an investment of **\$3500 inc GST**. You will receive a detailed Project Proposal which includes a full set of design plans including elevations, floor plans and 3D images of your dwelling. Your design will be quality assured to comply with all ACT Building and/or Development Approval criteria.

3. **Create a bespoke design** * for an investment of **\$77/hour inc GST**. The bespoke design option applies when a design surpasses the custom or modification options. You will receive a detailed Project Proposal which includes a full set of design plans including elevations, floor plans and 3D images of your dwelling. Your design will be quality assured to comply with all ACT Building and/or Development Approval criteria.

ACT Government Mandatory Contours Survey the ACT Government mandates we undertake a detailed contours survey with a registered surveyor. You will own this site survey and the investment is \$1100 in addition to the design agreement.

The documentation produced in this stage will be sufficient to support a finance application to a lending institution.

Once you have settled on the final design, style, and range of inclusions we will present you a fixed price quality proposal.

The HIA agreement will include the total price, and value will only be subject to change if you wish to alter the project or add something during the project construction.

*Housing Industry Association

Stage 2: Planning approval and selection of final inclusions

If you agree with the proposal and the HIA we will the advance to the Planning and Inclusions Stages. Our Planning Manager will initiate and coordinate the development application for the project.

The development application is managed in-house with the support of an external specialists, as required.

The duration of the development approval process is generally 14 to 26 weeks based on the complexity of the development application. Please note that the ACT government does not generally meet its legal timeframes for development applications.

Whilst managing the planning approvals we will simultaneously finalise the selection of your inclusions, with our inclusions team.

In the event the development application is unsuccessful because of law changes or departmental decision-making, only the investment of the planning process will apply as per the HIA agreement. This has never occurred thankfully as at November 2022.

Please note we would only undertake a development application if we believed it had a greater than 90% likelihood of approval.

Step 3: Building and delivery

As soon as the development application has been approved, we will commence the construction of your project.

The duration to build and deliver the project is on average 18-20 weeks. The average duration is 20 weeks for a Secondary Residence and 18 weeks for an extension.

Attachment A: Questions and Answers about Secondary Residences

What is a Secondary Residence?

Commonly known as a Secondary Residence or extension, a secondary residency in the ACT is a self-contained residential structure built on a block of land which is in addition to an existing residence.

The legislation provides that a Secondary Residence can be rented separately to an existing residence. This means that separate electrical, water and gas metering can be achieved on the majority of Secondary Residences.

What size can a Secondary Residence be?

A Secondary Residence should have a minimum size of 40m² floor area up to a maximum of 90m² floor area.

In addition to your Secondary Residence or extension., you can build additional structures such as garages, carports, alfresco areas and pergolas. These additional structures do not count towards the total gross floor area of the Secondary Residence; however, considerations may need to be taken account as it relates the total plot ratio allowable on your block.

What is the minimum block size you can build a Secondary Residence on?

A Secondary Residence can be considered on a minimum block size of 500m².

Do you require development approval to build a Secondary Residence?

Yes. Development approval application must be submitted to gain approval to build a Secondary Residence.

Development approvals are submitted to and assessed by the ACT Planning and Land Authority (ACTPLA).

A development approval application may be subject to meet the criteria set out in the following legislation and standards:

- *Building Act 2004;*
- *Heritage Act 2004;*
- *Planning and Development Act 2007;*
- *Planning and Development Regulation 2008;*
- *Utilities Act 2000;* and
- *Australian Standard AS 4299 Adaptable Housing.*

Once development approval is granted, we also need to obtain building approval?

Yes. Once we have secured development approval, we will need to complete building approval through a private building certifier.

What does adaptable housing mean and how does it relate to our Secondary Residence?

Secondary Residences are to be designed to be easily adaptable to meet the needs of people with a disability. This means that the dwelling should be designed to easily meet the *Australian Standard AS 4299 (Adaptable Housing)*.

What building classification will the Secondary Residence need to be?

Secondary Residences are classified as a Class 1a building. This is clearly defined in the Building Code of Australia. Structures like decks, garages, carports, stairs or ramps are classed as 10a buildings.

How many bedrooms can a Secondary Residence have?

Canberra Granny Flat Builders generally build Secondary Residences which have one to three bedrooms, with one to two bathrooms, a number of living spaces and a kitchen and laundry.

Will a Secondary Residence in my backyard increase my rates or land tax?

No (under the legislation in-force at this time).

Can a Secondary Residence be rented?

Yes, if all the correct planning approvals are obtained. These approvals are required for insurance purposes as well.

Does Canberra Granny Flat Builders manage the process to completion?

Yes. We manage every aspect of the build until it's ready to be occupied. Our turnkey guarantee means that we take full ownership and accountability from start to finish.

How much will a Secondary Residence cost me?

It depends on the design and function (that is, whether it has a kitchen, number of bathrooms etc.).

Do you offer flexibility in the Secondary Residence designs?

Yes. There are two options. We have created a range of designs you can choose from or we provide a custom-design service to suit your needs.

Do I get to choose the inclusions in my Secondary Residence?

Yes, if you wish to. We also offer a concierge service, for a fee, where one of our team will meet you at the retail supplier, record your choices and provide to our construction team.

Are the Secondary Residences built on-site or are they pre-fabricated in a factory?

We build the Secondary Residences on-site with locally based and licensed tradesmen, and ensure compliance with the applicable ACT laws.

Diagrams that will help us understand the planning pathways and potential issues

Aerial View of the Project Block

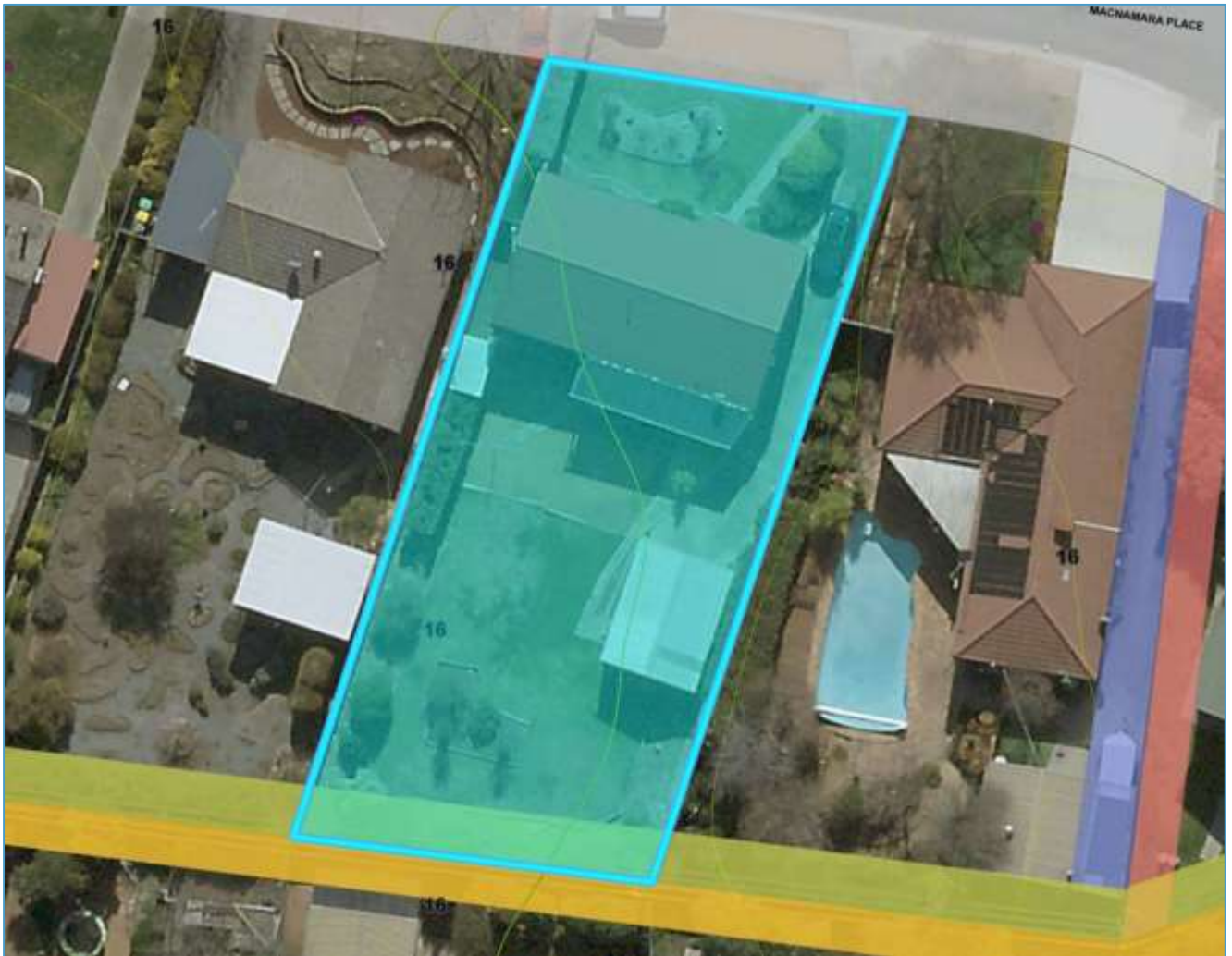

Aerial View of the Project Block with Contours and Easement



Aerial View of the Project Block with Building Offsets and Building Zone



Sketch up with measurements of roofing envelopes



Lengths of boundaries



Verge distance



Upper-level setbacks



External wall offset:



Unscreened element offset:



Front Access



Block dimensions

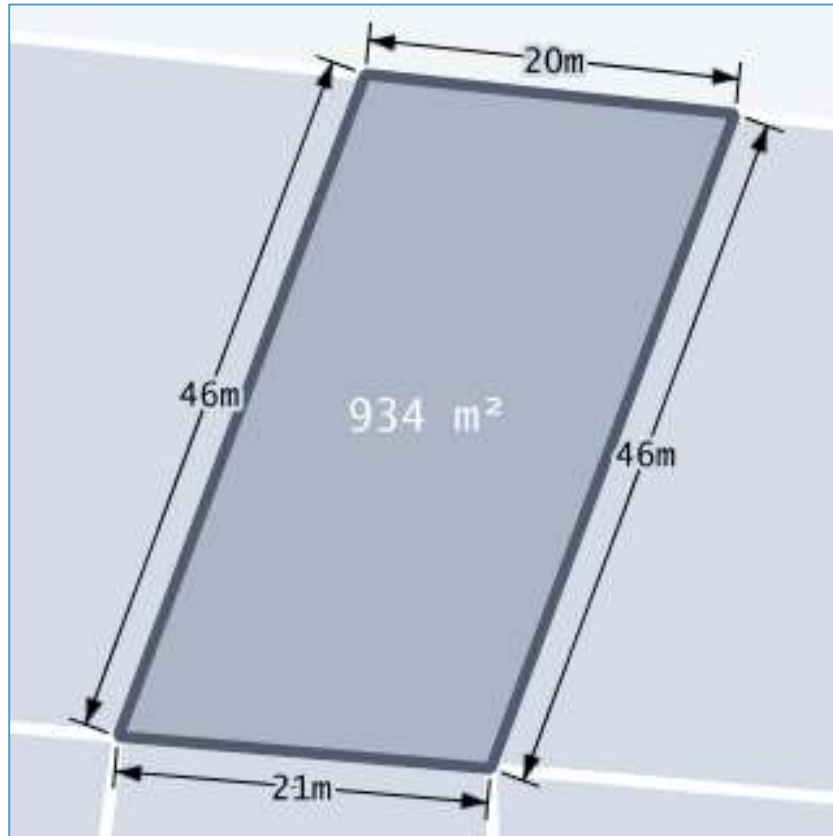

Floorplan (Price Finder)

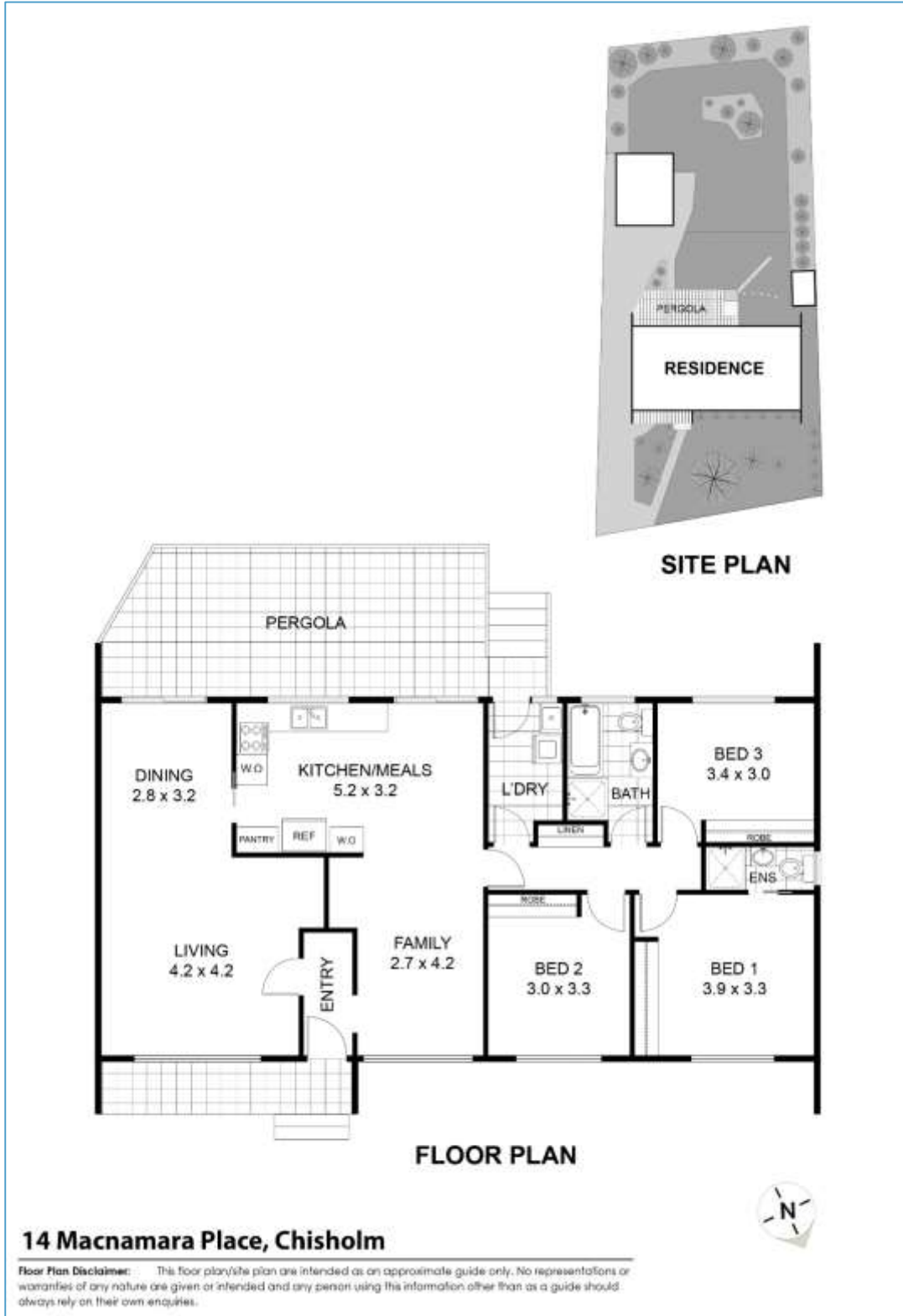

Potential Protected, Registered or Regulated Trees



Plumbing Tie Search

On the Tie Image, **red lines** indicate sewerage, **green lines** indicate storm water and **blue lines** indicate water supply. This search will only display the measurements and depth of the tie location for the selected block.

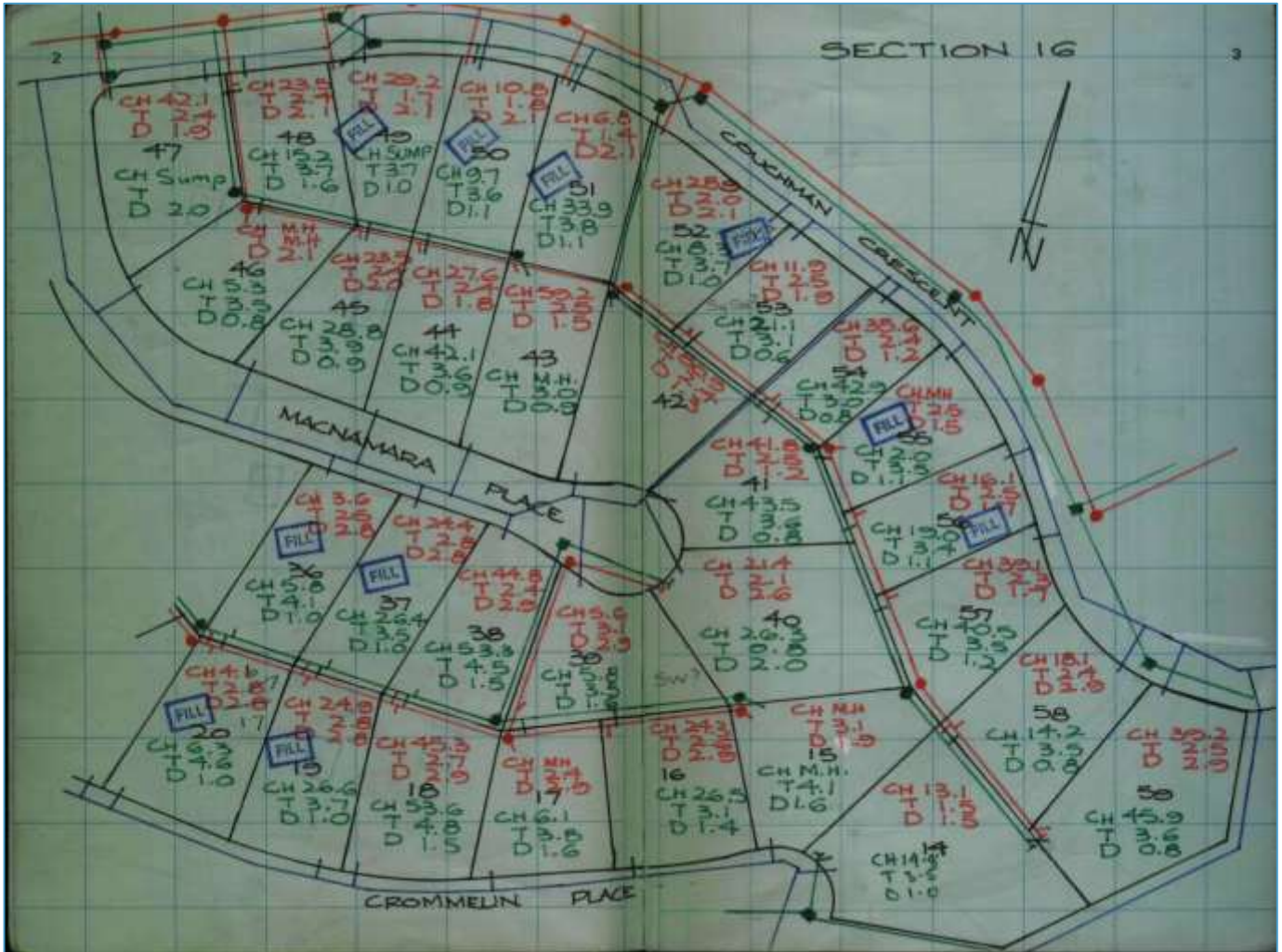

Large Block Boundary Setback Diagram

Appendix 1 – Boundary setback diagrams

Diagram 1: Large blocks approved before 18 October 1993
 (refer Tables 2A and 5)

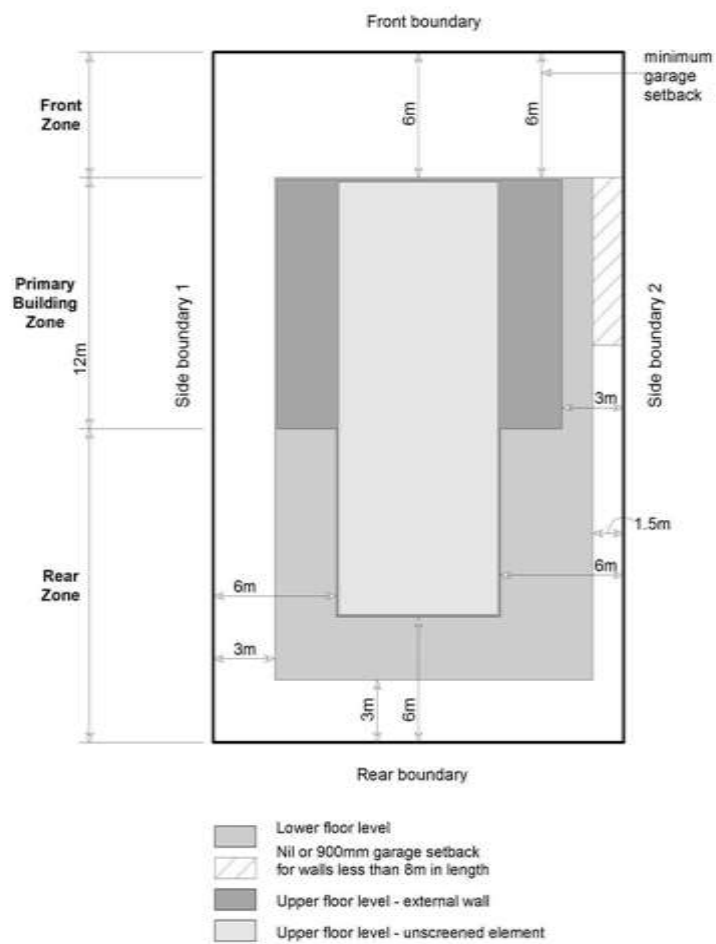

Caller Details

Contact: Canberra Granny Flat Builders
Company: Not supplied
Address: Unit 6, Level 2, 80 Emu Bank
Belconnen ACT 2617

Caller Id: 3025791
Phone: 1300 979 658
Email: info@cgfb.com.au

Dig Site and Enquiry Details

WARNING: The map below only displays the location of the proposed dig site and does not display any asset owners' pipe or cables. The area highlighted has been used only to identify the participating asset owners, who will send information to you directly.



User Reference: 14 Macnamara Place
Working on Behalf of: Private
Enquiry Date: 26/04/2023
Start Date: 26/04/2023
End Date: 26/04/2023

Address:
14 Macnamara Place
Chisholm ACT 2905

Job Purpose:
Excavation

Onsite Activities:
Mechanical Excavation

Location of Workplace:
Private

Location in Road:

- Check that the location of the dig site is correct. If not you must submit a new enquiry.
- Should the scope of works change, or plan validity dates expire, you must submit a new enquiry.
- Do NOT dig without plans. Safe excavation is your responsibility. If you do not understand the plans or how to proceed safely, please contact the relevant asset owners.

Notes/Description of Works:
Construction Secondary Residence

Your Responsibilities and Duty of Care

- The lodgement of an enquiry does not authorise the project to commence. You must obtain all necessary information from any and all likely impacted asset owners prior to excavation.
- If plans are not received within 2 working days, contact the asset owners directly & quote their Sequence No.
- ALWAYS perform an onsite inspection for the presence of assets. Should you require an onsite location, contact the asset owners directly. Please remember, plans do not detail the exact location of assets.
- Pothole to establish the exact location of all underground assets using a hand shovel, before using heavy machinery.
- Ensure you adhere to any State legislative requirements regarding Duty of Care and safe digging requirements.
- If you damage an underground asset you MUST advise the asset owner immediately.
- By using this service, you agree to Privacy Policy and the terms and disclaimers set out at www.byda.com.au
- **For more information on safe excavation practices, visit www.byda.com.au**

Asset Owner Details

The assets owners listed below have been requested to contact you with information about their asset locations within 2 working days. Additional time should be allowed for information issued by post. It is **your responsibility** to identify the presence of any underground assets in and around your proposed dig site. Please be aware, that not all asset owners are registered with the Before You Dig service, so it is **your responsibility** to identify and contact any asset owners not listed here directly.

** Asset owners highlighted by asterisks ** require that you visit their offices to collect plans.

Asset owners highlighted with a hash # require that you call them to discuss your enquiry or to obtain plans.

Seq. No.	Authority Name	Phone	Status
223884120	Evoenergy Icon Water	(02) 6293 5770	NOTIFIED
223884119	NBN Co NswAct	1800 687 626	NOTIFIED
223884118	Telstra NSW South	1800 653 935	NOTIFIED
223884121	Transport Canberra and City Services	(02) 7801 3960	NOTIFIED

END OF UTILITIES LIST

Asset location information

Applicant/Contractor

Job No.

34079195

DBYD Sequence No.

223884120

Company: Not Supplied
Contact: Canberra Granny Flat Builders
Telephone: +611300979658
Address: Unit 6, Level 2, 80 Emu Bank Belconnen ACT 2617
Email: support@cgfb.com.au

Work Details

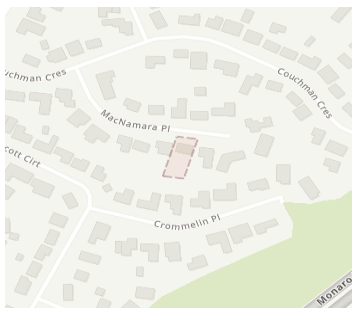

Suburb: Chisholm
Address: 14 Macnamara Place

Description: Construction Secondary Residence

Enquiry Date: 26-Apr-2023

Issue Date: 26-Apr-2023

GAS PIPELINE IN THE VICINITY

The records of Evoenergy Gas Networks indicate that Underground Assets/Pipes ARE present in the vicinity of and/or surrounding area of the above enquiry. Please read all the information and conditions below and overleaf.

IN THE EVENT OF A GAS EMERGENCY CALL 13 19 09 (24 hours)

CONDITIONS FOR WORKS IN THE VICINITY OF EVOENERGY GAS NETWORK ASSETS

Any information provided is valid only for 90 days from the date of issue. If the work operation extends beyond this period, or if the designs are altered in any way, you are requested to re-submit your proposal for re-assessment.

Consistent with the requirements of Part 2 General – Section 8 of the Utility Networks (Public Safety) Regulations 2001 No. 28, Evoenergy require that:

- The requestor shall ensure that all workers on site are aware of the presence of natural gas.
- The requestor shall ensure that under no circumstances will mechanical excavation be carried out within 1.0 metres of a gas main without there being a Zinfra Representative on site.

- The requestor shall be responsible to maintain the presence / visibilities of all gas markings.
- **No live or Isolated gas pipes shall be cut, altered or removed without APPROVAL from Zinfra.**

Note: Individual customer gas connections are generally not shown on the accompanying maps. For information regarding individual gas connections we recommend that you request a site meeting / inlet service location.

You can obtain additional information or arrange a site meeting by contacting Zinfra on **1300 503 237**. **Note that 24 hours notice is required for site meetings.**

Please read the following important information (overleaf)



The Essential First Step

evoenergy

WARNING. It is essential that ALL these documents be handed to the principal contractor carrying out the work. A photocopy may be taken for office records. All documents must be on site at the time of excavation. The information provided is to be used as guide only and does not absolve third parties in their "Duty of Care" obligations to take additional precautions where the work has the potential to impact on gas assets and the safety of people.

All work that may impact upon the Evoenergy Gas Network should be carefully planned with notification to Jemena (Zinfra) well in advance of commencement. This includes excavation of gas pipelines, crossings of pipelines by other underground infrastructure (drains, power cables, etc), road works or structural installations.

Evoenergy plans have been provided to show the position of underground gas mains and equipment in public gazetted roads only. Individual customers' services are not generally included on these plans. These plans have been prepared

solely for Evoenergy's own use and indicate the position of underground mains and installations relative to boundaries and kerbs as at the time the mains were installed, and do not necessarily reflect any subsequent changes eg: changes to road alignments.

Evoenergy and / or Jemena (Zinfra) will accept no liability for inaccuracies in the information or lack of information on such plans for any cause whatsoever arising. Persons excavating or carrying out other earthworks will be held responsible for any damage caused to underground mains and equipment, and the costs associated with replacement or repair.

Please note that the information contained on the map provided is not a method of determining gas availability for the purposes of connection to a natural gas supply. Please contact a gas retailer to determine the availability of gas as an energy source.

IN THE EVENT OF A GAS EMERGENCY CALL 13 19 09 (24 hours)

Extinguish all sources of ignition and keep the area clear of all persons. Any attempt by third parties to repair damaged gas mains or services may result in prosecution under the Utility Networks (Public Safety) Regulations 2001.



Asset location information

Applicant/Contractor

Job No.

34079195

DBYD Sequence No.

223884120

Company: Not Supplied
Contact: Canberra Granny Flat Builders
Telephone: +611300979658
Address: Unit 6, Level 2, 80 Emu Bank Belconnen ACT 2617
Email: support@cgfb.com.au

Work Details

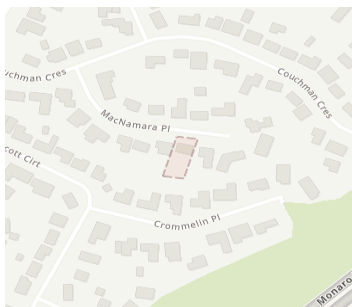

Suburb: Chisholm
Address: 14 Macnamara Place

Description: Construction Secondary Residence

Enquiry Date: 26-Apr-2023 Issue Date: 26-Apr-2023

Information

The approximate location of Evoenergy or Icon Water assets in the area-of-enquiry are shown on the attached maps.

Please review all attached maps to check whether there are Evoenergy or Icon Water utility assets within your work area.

Please refer to your Dial Before You Dig (DBYD) enquiry information to ensure that you have received asset maps from all relevant utility owners before you commence work.

Note that there may be additional pages attached dependent on what assets are found in the area; and that maps might be on pages of different sizes.

Individual customer gas connections are generally not shown on any attached Evoenergy Gas Network map. For information regarding individual gas connections we recommend that you request a site meeting / inlet service location as per Item 7 in the Disclaimer.

Comments

This information is valid from **26-Apr-2023** to **26-Jul-2023**

IN CASE OF EMERGENCY OR TO REPORT DAMAGE PHONE:
13 10 93 ELECTRICITY | **02 6248 3111** WATER AND SEWER | **13 10 09** GAS

Please read the following important information (overleaf)



Disclaimer

1. General location only

The Applicant acknowledges that:

- (a) while Icon Water and Evoenergy have used reasonable endeavours to keep Asset location records current, neither party makes any warranty, guarantee or representation as to the accuracy, currency or completeness of the information contained in the attached Asset Plans.
- (b) Asset Plans:
 - i. may not show all assets in the work area;
 - ii. show only the general and approximate location of Assets;
 - iii. may show the position of Assets relative to fences, buildings, property lines, kerbs and/or other points of reference that existed at the time the Assets were installed. Any subsequent alterations to those fences, buildings etc may not have been updated on the Asset Plans. Persons should not rely on such things as a point of reference to estimate location of the Assets.

2. Limitation of liability

To the maximum extent permitted by law:

- (a) subject to paragraph 2(b), Icon Water, Jemena and Evoenergy and the officers, employees and agents of each accept no responsibility or liability for any loss, damage, liability, cost, expense, claim or proceeding of whatever nature and howsoever arising, incurred by or awarded against the Applicant or its officers, employees, agents, contractors or subcontractors, arising out of, connected with or as a consequence of use of the Asset Plans or any inaccuracies in the Asset Plans;
- (b) where:
 - i. a Jemena or Evoenergy representative has, at the Applicants request, attended the work site to mark the location of Assets prior to commencement of any works on the work site, and
 - ii. the Jemena or Evoenergy representative has been proven to be negligent in marking the Asset locationthen Icon Water, Jemena and Evoenergy's liability, and the liability of the officers, employees and agents of each, is limited, at Icon Water / Jemena / Evoenergy's option, to re-attending the work site to re-mark the Asset location or paying the costs of having a third party attend the work site to re-mark the Asset location.

3. Evoenergy Authorisation and Accreditation for Working on or near the Electricity Network

Accreditation is the process of ensuring that a company or person, wishing to carry out work on or near Evoenergy electricity network, has the necessary level of skills, resources and insurance to undertake the work in a safe and reliable way. Evoenergy has obligations under the Utilities (Management of Electricity Network Assets Code) Determination 2013 to ensure that anyone working on or near its electricity network is adequately and safely trained. Evoenergy takes these obligations seriously.

Anyone working on or near Evoenergy's electricity network

must have the appropriate accreditation and authorisation to do so prior to commencing works.

To gain authorisation to work on or near the electricity network you will need to:

1. Ensure you or your company is accredited with Evoenergy by making an application with Evoenergy. The application form can be found on the Evoenergy website: www.evoenergy.com.au
2. Wait for Evoenergy to assess your application and notify you of the outcome.
3. Receive your Compliance tool login and QR code from Evoenergy as proof of authorisation. The QR code is required to be available at all times when working on or near the network.

For further information contact:

accreditations@evoenergy.com.au

4. Electricity cables to be treated as LIVE

ALL electricity cables and conductors identified on the attached Asset Plans, including those marked as 'Abandoned', **MUST** be treated as 'LIVE' and dangerous until such time that they are tested and proven to be 'DE-ENERGISED'. Evoenergy recommends that cables identified as 'Abandoned' and which may be impacted, severed, damaged and/or removed by excavation works be proven 'DE-ENERGISED' and safe before commencing full-scale excavations.

5. Location of Assets may change

Assets may be moved, or additional Assets may be installed at any time. Persons using the attached Asset Plans are advised to be alert for changed locations or new installations performed after the Issue Date. If work extends for a period of 3 months beyond the Issue Date, a new application **MUST** be made to Dial Before You Dig for up to date Asset Location Information.

6. Work to be undertaken without interference or damage to assets

Any work undertaken near Assets, including without limitation excavation, structures, material storage, heavy vehicle parking, blasting or change of surface level, must be performed in a way that does not interfere with the reliability of, or access to Icon Water or Evoenergy Assets, including electricity lines or plant. Persons excavating are required to exercise care if Assets are indicated on Asset Plans and will be held responsible for any damage caused through failure to exercise such care. Icon Water or Evoenergy (as applicable) will pursue the person responsible for causing the damage or interference to their Assets to recover costs and expenses incurred in remedying such damage or interference.

7. Asset location marking

You may request our representative to visit the work site to mark the approximate location of Assets by calling **02 6293 5770** (Water and Electricity – excluding streetlight assets) or **1300 503 237** (Gas) between 7:30 am and 4 pm. Irrespective of any mandatory directions given in this notice, Evoenergy recommends that a site visit be conducted before commencing any works near Assets. Appointments will be accepted only if the Asset Location Information Sequence



Number is supplied. The location and marking of Assets will not take place unless the Asset Location Advice and attached Asset Plans are in colour and to the same scale as supplied, and are at the work site. Evoenergy does not charge for these site visits. Alternatively, the Applicant may wish to engage a private underground Asset locator, at the Applicant's expense.

You are responsible for maintaining the presence / visibility of all markings and to ensure that all workers on site are aware of:

- the presence of Icon Water / Evoenergy infrastructure in the vicinity of the intended work and
- Icon Water, Jemena and Evoenergy's requirements.

NB: Arranging for marking of approximate Asset locations by either an Evoenergy representative or private underground asset locator will not relieve the Applicant and persons working on their behalf of responsibility to exercise care when working near Evoenergy / Icon Water Assets or for any damage they cause to Evoenergy / Icon Water Assets while performing works.

8. Underground Assets must be located by potholing

Potholing or other non-destructive techniques must be used until underground Assets are located. When located, excavation may commence provided that persons carrying out the excavation work must follow Evoenergy's recommended specifications concerning minimum safety distances when excavating within the vicinity of Icon Water or Evoenergy's networks. Unless otherwise approved by Jemena, **under no circumstances can mechanical excavation be carried out within 1.0 metres of a gas main without a Jemena Representative on site.**

9. Water, Sewer and Effluent Mains

Icon Water requires mandatory supervision by authorised Icon Water personnel when potholing and excavating within the vicinity of critical water and sewer network assets (as determined by Icon Water) or Icon Water mains with a diameter of 300mm and above. **All effluent mains are classified as critical assets.**

To arrange an inspection or for any emergency please call Icon Water **02 6248 3111**.

10. Substation Earthing Conductors

The information does not include details of substation earthing conductors. These are installed within the vicinity of pole and ground mounted substations. Earthing conductors extend 1.0m in each direction from the substation. However, please be aware that site-specific requirements mean earthing conductors may be installed beyond this distance. Further information can be provided upon request.

11. Indications of the Presence of Cables

The presence of cables or conduits may be indicated by the following warning and marking devices

- Letter "E" inscriptions on Kerbs or "Electrical" inscriptions on pit lids
- Danger signs on above ground posts, walls etc
- Thin Orange "Caution Electrical Cables" Warning Tape

- Orange /Black PLASTIC Polymeric slab (3-6mm thick x 200mm wide)
- Concrete Bricks or slabs (approx 200mm x 500mm)
- Orange PVC or white Asbestos Cement (AC) Conduit or Galvanized Pipe
- Cylindrical concrete "ACTEA Electric Cable" markers
- Weak Concrete encasement directly around cables / conduits
- Texture/ colour change of excavated material (bedding sand, cracker dust, clean fill)

Note that some cables may have been installed without the presence of such marking devices.

12. Gas mains

- (a) Evoenergy gas mains are managed by Jemena Asset Management Pty Ltd and operated by Zinfra.
- (b) Mandatory stand-by / supervision by Zinfra personnel is required when excavating within the vicinity of critical gas network assets OR where mechanical excavation is required within 1.0 metres of the gas network. Your activity around critical gas assets will be supervised by Zinfra at no charge for the first two hours. This supervision is to ensure the integrity of Evoenergy's assets is maintained.

Note: Charges may apply if stand-by is required for longer than two hours.

Please contact Zinfra on **1300 503 237** between 7.30 am and 4 pm if you require a stand-by person.

13. High Pressure Gas Network Assets

You must supply Jemena with your proposal of works including a written outline of your works and design plans for review. It may take up to four weeks for Jemena to review your works proposal. Following review, we will advise you of Jemena's requirements for protecting the High Pressure gas main.

Please mail your proposed works details to:

Jemena Asset Management Pty Ltd
Attention: Land Services Department
PO Box 1220
North Sydney NSW 2059

or email land.services@jemena.com.au

Please note that a duty of care exists to ensure that this gas main is not compromised or damaged during future development or construction work.

14. Streetlight Assets

Streetlight assets in the ACT are owned and maintained by the ACT Government. You expressly acknowledge and agree that

- (a) Evoenergy does not maintain streetlight asset information; and
- (b) any such information provided by Evoenergy may not be up to date, reliable or complete and is provided strictly on an "as is" basis without any warranty of any kind. Please contact Access Canberra on **13 22 81** during business hours if you require further information.

THIS DOCUMENT AND ASSOCIATED ASSET PLANS MUST BE KEPT AT THE WORK SITE.













Icon Water: Effluent Re-use Network Legend



Hydrant

-  Overhead Filling Point
-  Mill Cock
-  Pillar Hydrant
-  High Capacity
-  Spring Hydrant



Fitting

-  Outlet
-  Inlet
-  Blank Flange
-  Dual Service Tee
-  End Cap
-  Gibault Joint
-  Maintenance Hole
-  Open End
-  Orifice Plate
-  Reducer
-  Tapping Band Bend

Service Connection (Meter)

-  Flow Element
-  Billing Large Diameter
-  Billing Small Diameter

Test Station

-  Flow Recording Device
-  Sampling Point



Pump

-  Pump



System Valve

-  <all other values>
-  Ball Valve
-  Butterfly Valve
-  Cone Valve
-  Gate Valve
-  Globe Valve
-  Needle Valve
-  Scour Valve

Control (Protection) Valve

-  DCV Double Check
-  Reflux Valve
-  AV Single Air Valve
-  DAV Double Air Valve
-  Enhanced Double Air Valve
-  RPZD Reduced Pressure Zone Valve
-  Pressure Relief Valve
-  Float Valve





Curb Stop Valve

-  Main Cock Valve
-  Tapping Band Valve





Reservoir Supply

-  Reservoir Supply





Main

-  Rising Main
-  Bulk Supply
-  Distribution Main
-  Reticulation

Lateral Line

-  Irrigation
-  Wash Down
-  Overflow
-  Scour
-  Drain

Effluent Structure

-  Dam
-  Pump Station
-  Reservoir Structure
-  Treatment Plant
-  Valve Chamber

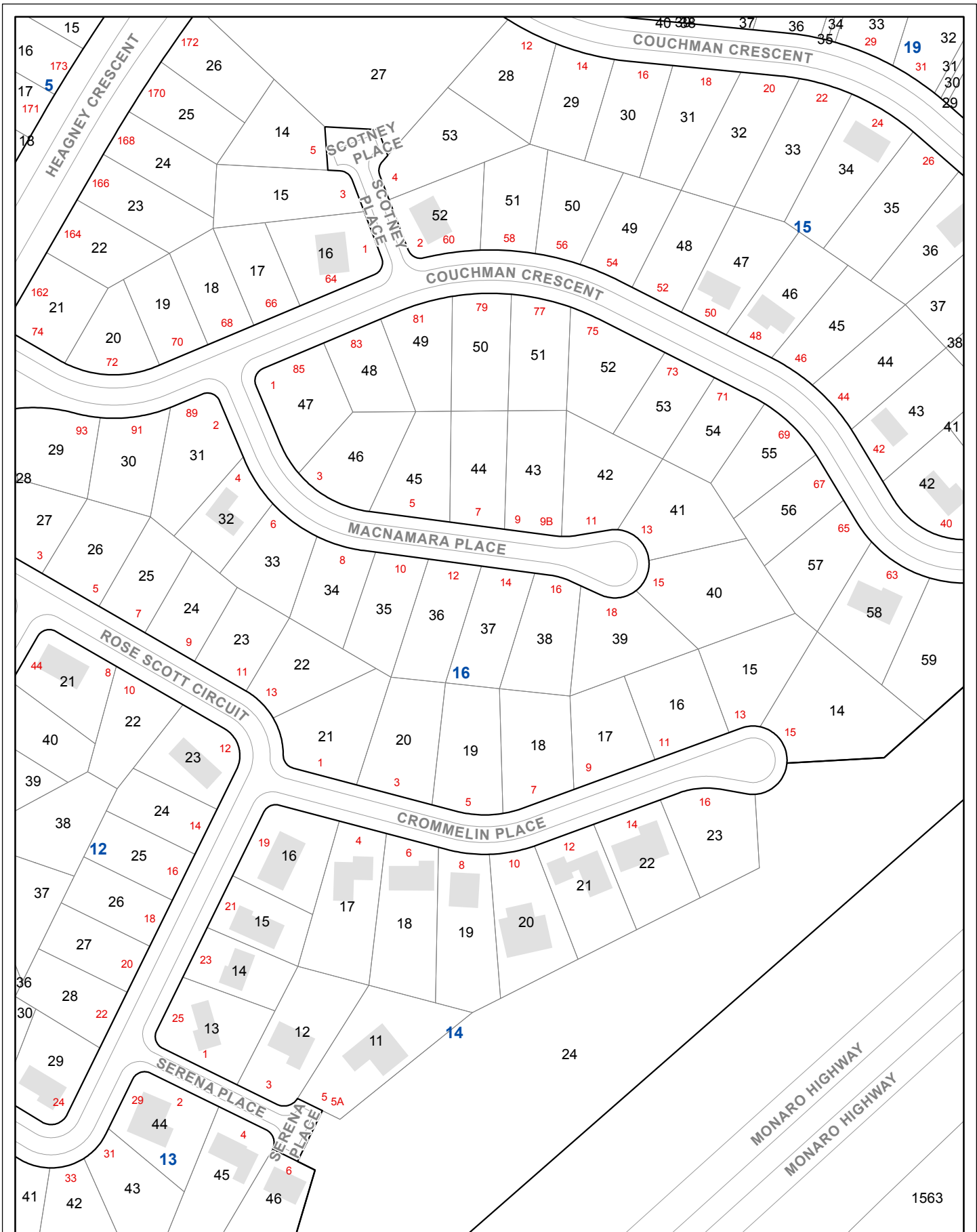

All network distribution data is the property of Icon Water Limited and no warranty as to the accuracy or completeness of the information is provided. No liability for any loss or damage arising from the use of this information will be accepted. Copyright Icon Water Limited 2023.

Seq #: 223884120

14 Macnamara Place, Chisholm

Effluent Network



ACT Cadastral Information supplied by the ACT Environment & Sustainable Development Directorate. © ACT Gov. 2023.

NSW Cadastre © Land and Property Information (A division of the Department of Finance and Services) 2023.

0 5 10 20 30 40 M





ELECTRICITY NETWORK LEGEND

Support Structure (Distribution)

-  Pole
-  Streetlight-Only Pole

Support Structure (Transmission)

-  Pole
-  Tower
-  Yard Structure



Underground Structure

-  Pit



Recloser

-  Recloser

Building

-  Zone Building
-  Standalone Chamber

Switches

-  Air Break
-  Load Break
-  Overhead Link

Fuse

-  Drop Out Fuse

Service Point

-  Service Point

Streetlight

-  Streetlight Controller

Joint

-  Cable Joint

Underground Earth Cable

-  Underground Earth Cable

Fibre Communication Cable

-  Fibre Communication Cable



Copper Communication Cable

-  Pilot Cable



Streetlight

-  Streetlight
-  Streetlight Controller
-  Streetlight Photoelectric Controller
-  Other Streetlight Support
-  Streetlight Column



Streetlight Cable

-  Overhead Streetlight Line
-  Underground Streetlight Line, In Service
-  Underground Streetlight Line, Abandoned

Transmission Line

-  Overhead Transmission Line
-  Underground Transmission Line, In Service
-  Underground Transmission Line, Abandoned



HV Electric Lines

-  Overhead HV Electric Line
-  Underground HV Electric Line, In Service
-  Underground HV Electric Line, Abandoned



LV Electric Lines

-  Overhead LV Electric Line

Underground LV Electric Line <= 50 mm

-  Underground LV Electric Line, In Service
-  Underground LV Electric Line, Abandoned



Underground LV Electric Line > 50 mm

-  Underground LV Electric Line, In Service
-  Underground LV Electric Line, Abandoned



Service Lines

-  Overhead Service Line





Underground Service Line <= 50 mm

-  Underground Service Line, In Service
-  Underground Service Line, Abandoned













Underground Service Line > 50 mm

-  Underground Service Line, In Service
-  Underground Service Line, Abandoned







DuctBank

-  <all other values>
-  Conduit
-  DepthIndicatorDeep
-  DepthIndicatorShallow

Ground Mounted Structure

-  Streetlight Control Cubicle
-  Distribution Box
-  Point-Of-Entry Cubicle
-  HV Switching Station
-  Kiosk
-  Padmount
-  Link Pillar
-  Micro Pillar
-  Mini Pillar
-  Pregnant Column
-  Communication Cubicle
-  SCADA Cubicle

Electric Supply Site

-  132kV Switching Station
-  Bulk Supply Station
-  Mobile Zone Substation
-  Zone Substation
-  Overhead Substation
-  Chamber Substation
-  Stockade

IMPORTANT NOTE:

- The term 'ABANDONED' is utilised to identify an underground cable that has been physically disconnected from the Evoenergy electricity network, is not in service and cannot readily be put back into service without specific augmentation and/or reconnection works. Cable(s) identified by Evoenergy as 'ABANDONED' have been discarded in-situ by Evoenergy. ALL cables should be treated as 'LIVE' and Dangerous until proven de-energised and safe.

All network distribution data is the property of Evoenergy and no warranty as to the accuracy or completeness of the information is provided. No liability for any loss or damage arising from the use of this information will be accepted.

© Evoenergy 2022.

evoenergy



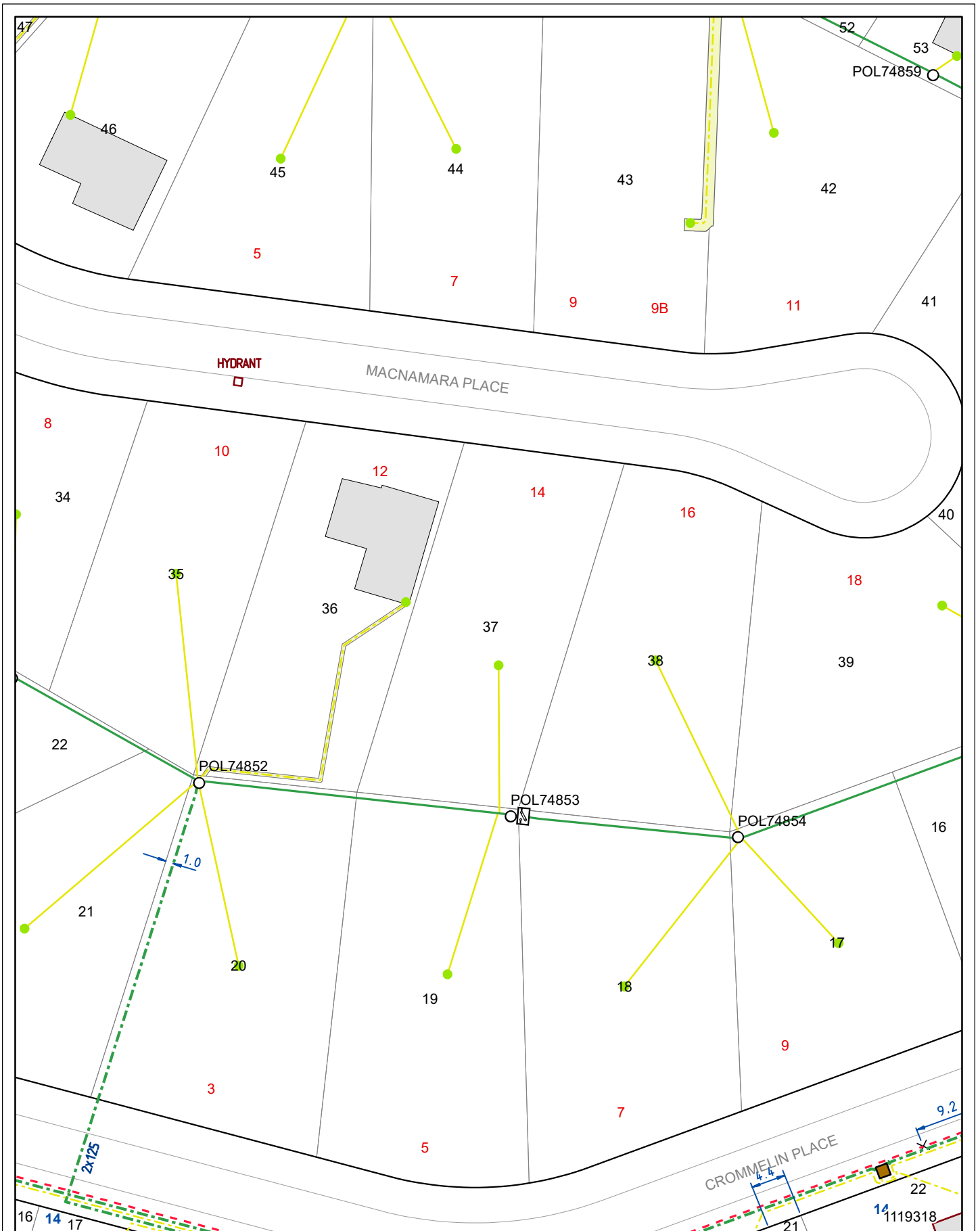

All network distribution data is the property of Evoenergy and no warranty as to the accuracy or completeness of the information is provided. No liability for any loss or damage arising from the use of this information will be accepted. Copyright © Evoenergy 2023.

Seq #: 223884120
14 Macnamara Place, Chisholm

Evoenergy Electricity Network
evoenergy

ACT Cadastral Information supplied by the ACT Environment & Sustainable Development Directorate. © ACT Gov. 2023.

NSW Cadastre © Land and Property Information (A division of the Department of Finance and Services) 2023.

0 3 6 12 18 24 M











GAS NETWORK LEGEND

GasStation CRITICAL

-  DistrictRegulator
-  TrunkReceivingStation
-  PrimaryRegulatingStation
-  BulkMeteringStation
-  PressureMonitoringStation
-  ScraperStation
-  BoundaryRegulatorSet
-  SecondaryBoundaryRegulatorSet
-  ValveStation



GasDevice

-  <all other values>
-  IsolationValve
-  Odouriser
-  Siphon
-  WaterbathHeater
-  Filter
-  Catalyst Heater
-  Silencer
-  Regulator









GasDevice High Risk Valve CRITICAL

-  HighRiskAreaIsolation



GasMeter

-  DomesticMeter
-  IndustCommMeter
-  SecondaryMeterSet

GasFitting

-  EndCap
-  Tee
-  ExpansionJoint
-  Flange
-  Reducer
-  Cross
-  ServiceSaddle
-  InsulationJoint
-  GaugingPoint



CPAnode

-  AnodeGroundBed
-  SacrificialAnode

CPRectifier

-  TransformerRectifier





CP Cable

-  CPRectifierCable
-  CPGroundBedCable



Conduit

-  Conduit



GasStructure

-  <all other values>
-  CPKiosk
-  Pit
-  StationStructure





GasService

-  <all other values>
-  Gas Service IN USE
-  Gas Service NOT IN USE









GasService STEEL or MAOP >= 1050 OR DIA >= 75mm CRITICAL

-  Gas Service IN SERVICE
-  Gas Service NOT IN SERVICE

GasPipe

-  <all other values>
-  DistributionMain, Nylon, InService
-  Gas Pipe NOT IN USE
-  DistributionMain, PE, InService
-  DistributionMain, Copper, InService

GasPipe STEEL OR MAOP >= 1050 OR DIA >= 75mm CRITICAL

-  DistributionMain, Copper, InService
-  DistributionMain, Nylon, InService
-  DistributionMain, PE, InService
-  PrimaryMain, Steel, InService
-  PrimaryMain, Steel, Proposed
-  SecondaryMain, Steel, InService
-  SecondaryMain, Steel, Proposed
-  TransmissionMain, Steel, InService
-  Gas Pipe NOT IN USE

R 10.0 = DISTANCE TO ROAD
 B 10.0 = DISTANCE TO BOUNDARY
 E 10.0 = DISTANCE TO END
 C 10.0 = DISTANCE TO CHANGE OF DIRECTION

 = DISTANCE FROM MAIN TO KERB
 = DISTANCE FROM MAIN TO BOUNDARY

All network distribution data is the property of Evoenergy and no warranty as to the accuracy or completeness of the information is provided. No liability for any loss or damage arising from the use of this information will be accepted.

Copyright © Evoenergy 2018.



evoenergy

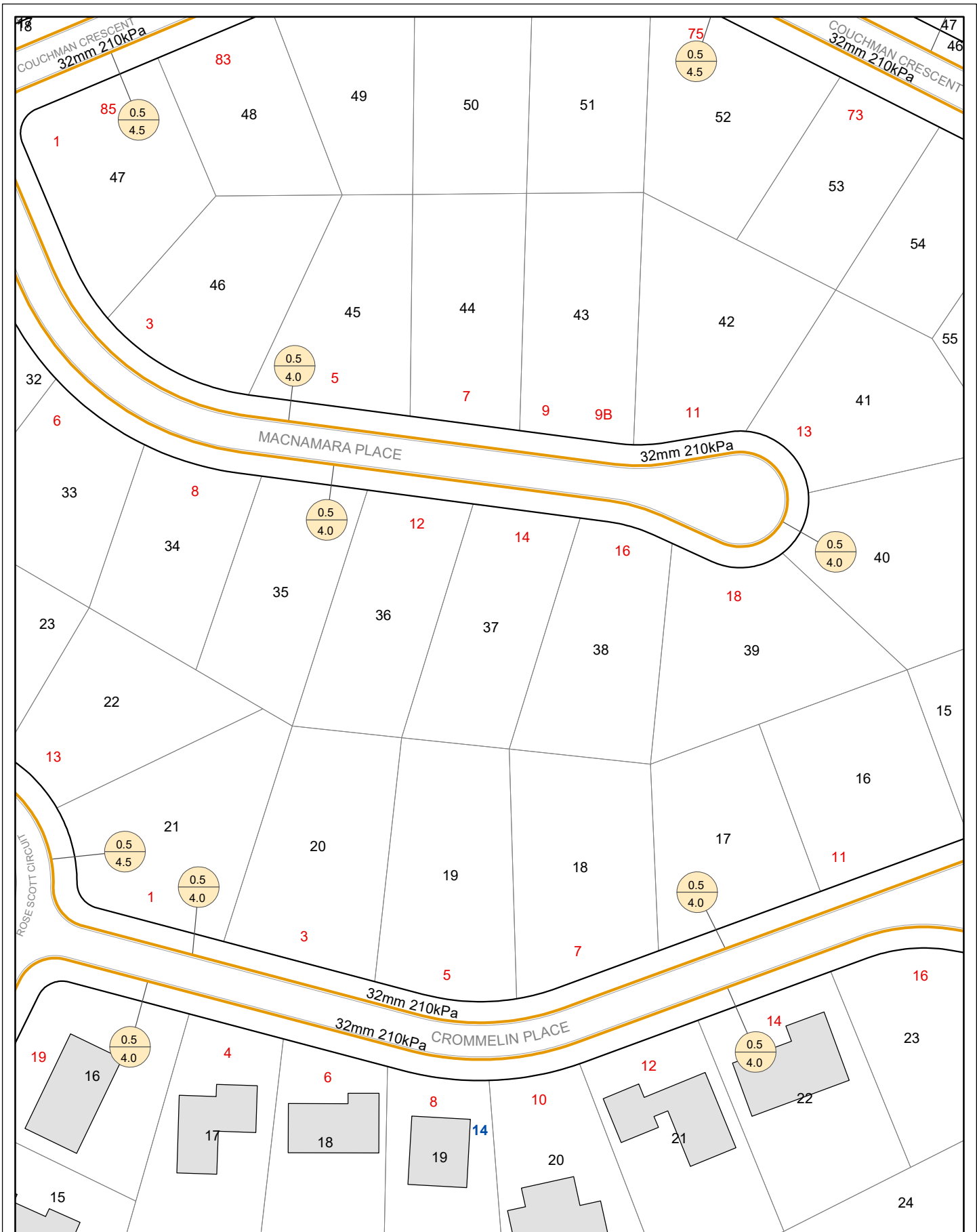

All network distribution data is the property of Evoenergy and no warranty as to the accuracy or completeness of the information is provided. No liability for any loss or damage arising from the use of this information will be accepted. Copyright © Evoenergy 2023.

Seq #: 223884120

14 Macnamara Place, Chisholm

Evoenergy Gas Network

evoenergy

ACT Cadastral Information supplied by the ACT Environment & Sustainable Development Directorate. © ACT Gov. 2023.

NSW Cadastre © Land and Property Information (A division of the Department of Finance and Services) 2023.

0 4.5 9 18 27 36 M



Icon Water: Sewer Network Legend

Abandoned Point

- ✕ Abandoned Point

Maintenance Hole

- Active
- De-Commissioned

Fitting

- ^{BVR} Buried Vertical Riser
- Dead End
- ▶ Reducer
- Riser
- Tee

Service Connection

- Service Connection

DischargePoint

- ⌋ DischargePoint

Gauging Point / Test Station

- ◆ ChemicalTransducer
- ◆ ElectroMagnetic
- ◆ Flume
- ◆ PressureTransducer
- ◆ Sonic
- ◆ Venturi
- ◆ WeirGauge

Inspection Shaft

- ^{SIS} ● Special Inspection Shaft
- ^{SMS} ● Standard 225 Inspection Shaft

Clean Out Point

- ^{RP} ● Rodding Point

Control (Protection) Valve

- ◇ Air Valve
- ↶ Reflux Valve

Pump

- Pump

Storage Tank / Vault

- ▣ Storage Tank / Vault

SystemControlValve

- ^{SCOUR} ⚡ Scour Valve
- ⊙ Ball Valve
- ^{PLUG} ⚡ Plug
- ⚡ Gate Valve
- ^{SL} ⚡ Stop Log
- ^P ⚡ Penstock

Sewer Structures

- ◇ Odour Scrubber
- ⊕ Sewer Fan
- ^{SVE} ● Vent

Vertical Drop

- ^{SVD} ● Vertical Drop

VortexDrop

- ^V ▼ VortexDrop

Weir

- ^W ● Weir

Gravity Main

- Vent Pipe
- Reticulation Main
- Trunk Main
- Tunnel
- Siphon
- Overflow Pipe
- Inline Storage

Pressure Main

- Pressure Main

Lateral Line

- Property Service Line
- Scour Line

De-Commissioned Mains

- De-Commissioned Mains

Abandoned Mains

- Abandoned Mains

Sewer Structure

- DiversionChamber
- DiversionPoint
- PumpStation
- SplitManhole
- StorageBasin
- TreatmentPlant
- DischargeStructure
- PipeBridge
- SeptageFacility
- ValveChamber

All network distribution data is the property of Icon Water Limited and no warranty as to the accuracy or completeness of the information is provided. No liability for any loss or damage arising from the use of this information will be accepted. Copyright Icon Water Limited 2019.



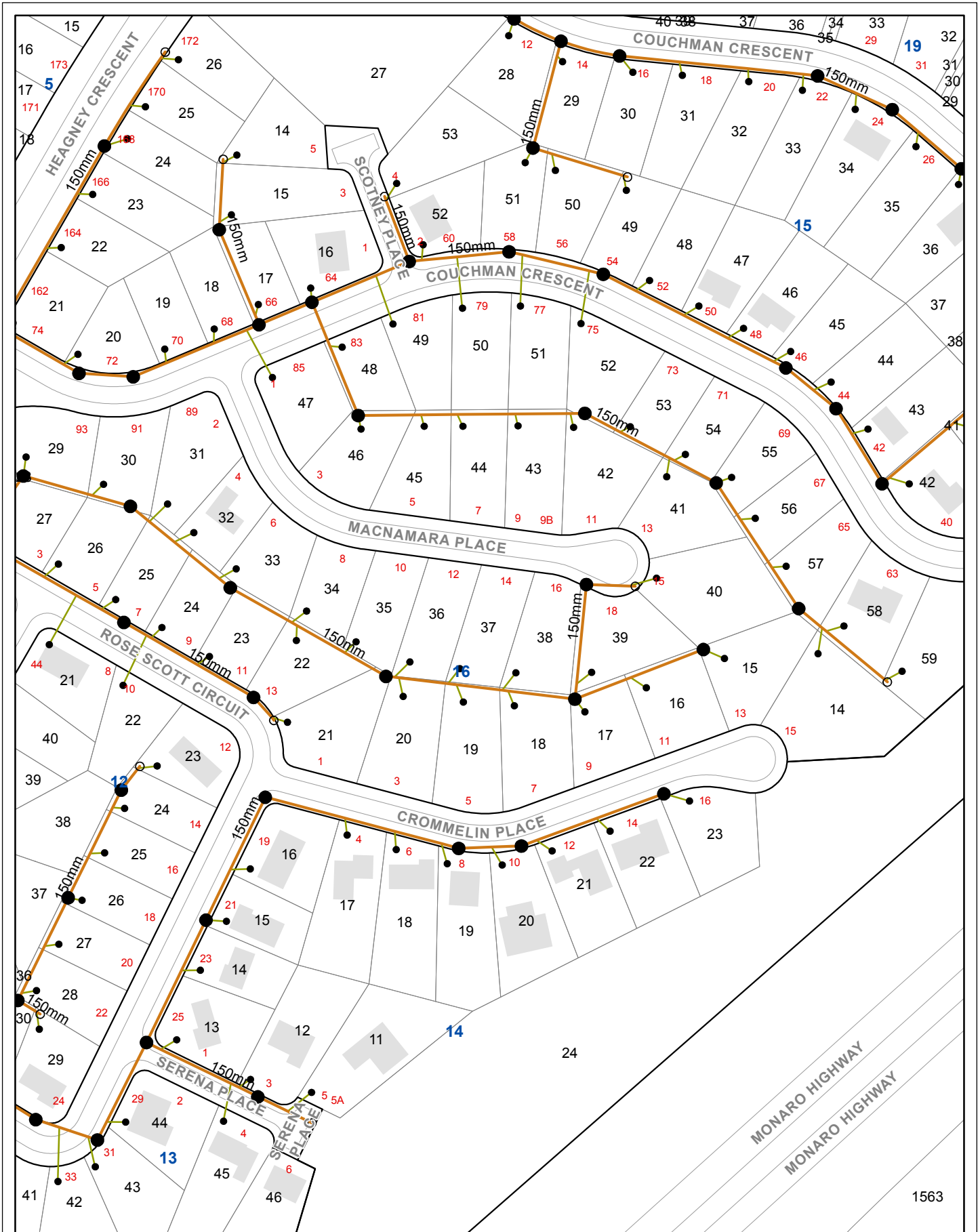

All network distribution data is the property of Icon Water Limited and no warranty as to the accuracy or completeness of the information is provided. No liability for any loss or damage arising from the use of this information will be accepted. Copyright Icon Water Limited 2023.

Seq #: 223884120

14 Macnamara Place, Chisholm

Sewer Network



ACT Cadastral Information supplied by the ACT Environment & Sustainable Development Directorate. © ACT Gov. 2023.





NSW Cadastre © Land and Property Information (A division of the Department of Finance and Services) 2023.

0 5 10 20 30 40 M





Icon Water: Water Network Legend



Hydrant

-  HighCapacity
-  MillCock
-  OverheadFillingP...
-  PillarHydrant
-  SpringHydrant

Service Connection (Meter)

-  Flow Element
-  Billing Large Diameter
-  Billing Small Diameter

Test Station

-  Pressure Recording Device
-  Flow Recording Device
-  Sampling Point









Pump

-  Pump







System Valve: Ball

-  Ball Valve







System Valve: Butterfly

-  Altitude Inlet Control
-  Back Up
-  DualFlowRate
-  Flow Altitude
-  Flow Rate Control
-  Isolation
-  Normally Closed Isolation
-  Pump Control



System Valve: Butterfly Motorised

-  Altitude Inlet Control
-  Back Up
-  DualFlowRate
-  Flow Altitude
-  Flow Rate Control
-  Isolation
-  Normally Closed Isolation







Control Valve

-  Pump Control
-  Control (Protection) Valve
-  Double Air
-  Double Check
-  Enhanced Double Air Valve
-  Float Valve
-  Pressure Relief Valve
-  Reduced Pressure Zone
-  Reflux Valve
-  Single Air

System Valve: Cone

-  Altitude Inlet Control
-  Outlet Control









System Valve: Gate

-  Zone Valve
-  Normally Closed Isolation
-  Isolation
-  Flow Rate Control
-  Back Up
-  Altitude Inlet Control

System Valve: Gate Motorised

-  Isolation

System Valve: Globe

-  Pump Control
-  Pressure Sustaining
-  Pressure Reducing
-  Flow Rate Control
-  Flow Altitude
-  Outlet Control
-  Back Up
-  Altitude Inlet Control

System Valve: Needle

-  System Valve: Needle





System Valve: Scour

-  System Valve: Scour



Network Structure

-  Service Reservoir
-  Treatment Plant Reservoir
-  NonPotable Water Reservoir
-  Minor Tanks

Main

-  Reticulation Main
-  Distribution Main
-  Bulk Supply Main
-  Rising Main







Lateral Line

-  Domestic Service
-  Fire Service
-  Overflow
-  Wash Down
-  Scour
-  Drain

Abandoned Mains and Lateral Lines

-  Abandoned Mains and Lateral Lines

Water Structure

-  Dam
-  Pipe Bridge
-  Pump Station
-  Reservoir Structure
-  Treatment Plant
-  Valve Chamber

Warning Zone:
Contact Icon Water before any excavation in this area 62483111



All network distribution data is the property of Icon Water Limited and no warranty as to the accuracy or completeness of the information is provided. No liability for any loss or damage arising from the use of this information will be accepted. Copyright Icon Water Limited 2019.



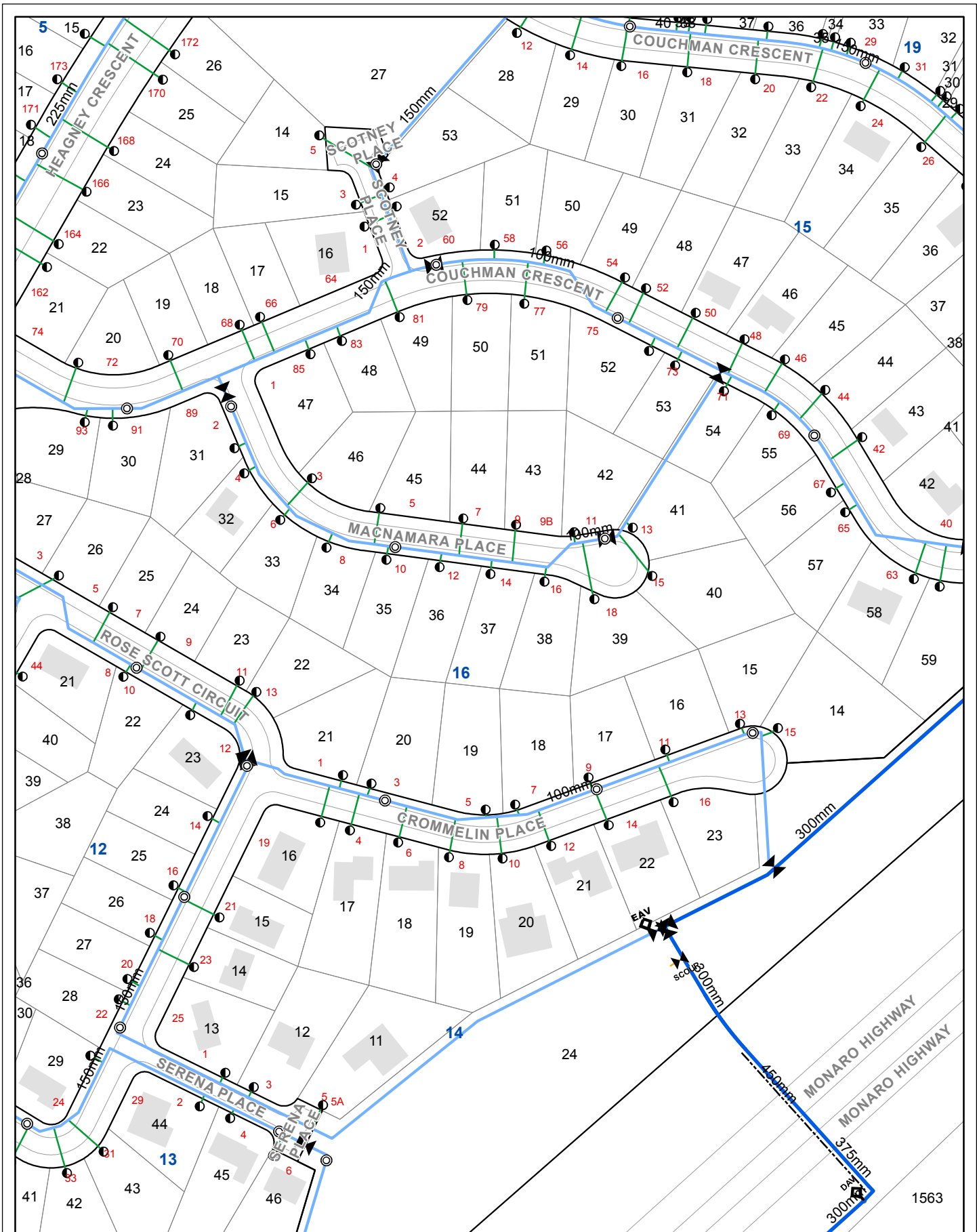

All network distribution data is the property of Icon Water Limited and no warranty as to the accuracy or completeness of the information is provided. No liability for any loss or damage arising from the use of this information will be accepted. Copyright Icon Water Limited 2023.

Seq #: 223884120

14 Macnamara Place, Chisholm

Water Network



ACT Cadastral Information supplied by the ACT Environment & Sustainable Development Directorate. © ACT Gov. 2023.

NSW Cadastre © Land and Property Information (A division of the Department of Finance and Services) 2023.

0 5 10 20 30 40 M





Working near nbn™ cables

nbn has partnered with Dial Before You Dig to give you a single point of contact to get information about **nbn** underground services owned by **nbn** and other utility/service providers in your area including communications, electricity, gas and other services. Contact with underground power cables and gas services can result in serious injury to the worker, and damage and costly repairs. You must familiarise yourself with all of the Referral Conditions (meaning the referral conditions referred to in the DBYD Notice provided by **nbn**).

Practice safe work habits

Once the DBYD plans are reviewed, the Five P's of Excavation should be adopted in conjunction with your safe work practices (which must be compliant with the relevant state Electrical Safety Act and Safe Work Australia "Excavation Work Code of Practice", as a minimum) to ensure the risk of any contact with underground **nbn** assets are minimised.



Plan: Plan your job by ensuring the plans received are current and apply to the work to be performed. Also check for any visual cues that may indicate the presence of services not covered in the DBYD plans.



Prepare: Prepare for your job by engaging a DBYD Certified Plant Locator to help interpret plans and identify on-site assets. Contact **nbn** should you require further assistance.

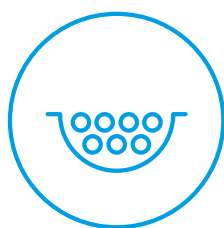

Pothole: Non-destructive potholing (i.e. hand digging or hydro excavation) should be used to positively locate **nbn** underground assets with minimal risk of contact and service damage.

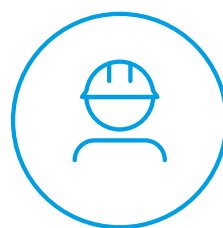

Protect: Protecting and supporting the exposed **nbn** underground asset is the responsibility of the worker. Exclusion zones for **nbn** assets are clearly stated in the plan and appropriate controls must be implemented to ensure that encroachment into the exclusion zone by machinery or activities with the potential to damage the asset is prevented.

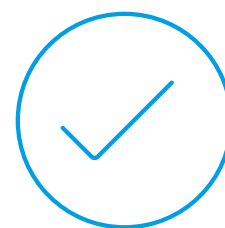

Proceed: Proceed only when the appropriate planning, preparation, potholing and protective measures are in place.

Working near **nbn**TM cables

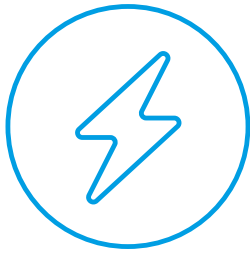

Identify all electrical hazards, assess the risks and establish control measures.

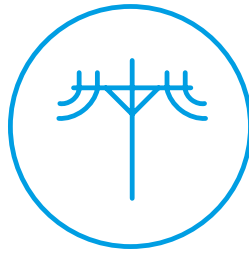

When using excavators and other machinery, also check the location of overhead power lines.

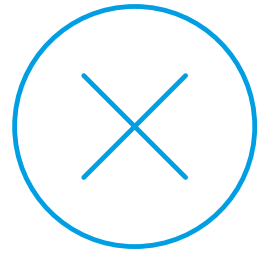

Workers and equipment must maintain safety exclusion zones around power lines.

Once all work is completed, the excavation should be re-instated with the same type of excavated material unless specified by **nbn**. Please note:

- Construction Partners of **nbn** may require additional controls to be in place when performing excavation activities.
- The information contained within this pamphlet must be used in conjunction with other material supplied as part of this request for information to adequately control the risk of potential asset damage.

Contact

All **nbn**TM network facility damages must be reported online [here](#).
For enquiries related to your DBYD request please call 1800 626 329.

Disclaimer

This brochure is a guide only. It does not address all the matters you need to consider when working near our cables. You must familiarise yourself with other material provided (including the Referral Conditions) and make your own inquiries as appropriate.

nbn will not be liable or responsible for any loss, damage or costs incurred as a result of reliance on this brochure.

This document is provided for information purposes only. This document is subject to the information classification set out on this page. If no information classification has been included, this document must be treated as UNCLASSIFIED, SENSITIVE and must not be disclosed other than with the consent of nbn co. The recipient (including third parties) must make and rely on their own inquiries as to the currency, accuracy and completeness of the information contained herein and must not use this document other than with the consent of nbn co. Copyright © 2021 nbn co limited. All rights reserved.



To: Canberra Granny Flat Builders
Phone: Not Supplied
Fax: Not Supplied
Email: support@cgfb.com.au

Dial before you dig Job #:	34079195	
Sequence #	223884119	
Issue Date:	26/04/2023	
Location:	14 Macnamara Place , Chisholm , ACT , 2905	

Information

The area of interest requested by you contains one or more assets.

nbn™ Assets	Search Results
Communications	Asset identified
Electricity	No assets

In this notice **nbn™ Facilities** means *underground fibre optic, telecommunications and/or power facilities, including but not limited to cables, owned and controlled by nbn™*

Location of nbn™ Underground Assets

We thank you for your enquiry. In relation to your enquiry at the above address:

- **nbn's** records indicate that there **ARE nbn™** Facilities in the vicinity of the location identified above ("Location").
- **nbn** indicative plan/s are attached with this notice ("Indicative Plans").
- The Indicative Plan/s show general depth and alignment information only and are not an exact, scale or accurate depiction of the location, depth and alignment of **nbn™** Facilities shown on the Plan/s.
- In particular, the fact that the Indicative Plans show that a facility is installed in a straight line, or at uniform depth along its length cannot be relied upon as evidence that the facility is, in fact, installed in a straight line or at uniform depth.
- You should read the Indicative Plans in conjunction with this notice and in particular, the notes below.
- You should note that, at the present time, the Indicative Plans are likely to be more accurate in showing location of fibre optics and telecommunications cables than power cables. There may be a variation between the line depicted on the Indicative Plans and the location of any power cables. As such, consistent with the notes below, particular care must be taken by you to make your own enquiries and investigations to precisely locate any power cables and manage the risk arising from such cables accordingly.
- The information contained in the Indicative Plan/s is valid for 28 days from the date of issue set out above. You are expected to make your own inquiries and perform your own investigations (including engaging appropriately qualified plant locators, e.g DBYD Certified Locators, at your cost to locate **nbn™**

Facilities during any activities you carry out on site).

We thank you for your enquiry and appreciate your continued use of the Dial Before You Dig Service. For any enquiries related to moving assets or Planning and Design activities, please visit the [nbn Commercial Works](#) website to complete the online application form. If you are planning to excavate and require further information, please email dbyd@nbnco.com.au or call 1800 626 329.

Notes:

1. You are now aware that there are **nbn**TM Facilities in the vicinity of the above property that could be damaged as a result activities carried out (or proposed to be carried out) by you in the vicinity of the Location.
2. You should have regard to section 474.6 and 474.7 of the *Criminal Code Act 1995 (CoA)* which deals with the consequences of interfering or tampering with a telecommunications facility. Only persons authorised by **nbn** can interact with **nbn's** network facilities.
3. Any information provided is valid only for **28 days** from the date of issue set out above.

Referral Conditions

The following are conditions on which **nbn** provides you with the Indicative Plans. By accepting the plans, you are agreeing to these conditions. These conditions are in addition, and not in replacement of, any duties and obligations you have under applicable law.

1. **nbn** does not accept any responsibility for any inaccuracies of its plans including the Indicative Plans. You are expected to make your own inquiries and perform your own investigations (including engaging appropriately qualified plant locators, e.g DBYD Certified Locators, at your cost to locate **nbn**TM Facilities during any activities you carry out on site).
2. You acknowledge that **nbn** has specifically notified you above that the Indicative Plans are likely to be more accurate in showing location of fibre optics and telecommunications cables than power cables. There may be a variation between the line depicted on the Indicative Plans and the location of any power cables.
3. You should not assume that **nbn**TM Facilities follow straight lines or are installed at uniformed depths along their lengths, even if they are indicated on plans provided to you. Careful onsite investigations are essential to locate the exact position of cables.
4. In carrying out any works in the vicinity of **nbn**TM Facilities, you must maintain the following minimum clearances:
 - 300mm when laying assets inline, horizontally or vertically.
 - 500mm when operating vibrating equipment, for example: jackhammers or vibrating plates.
 - 1000mm when operating mechanical excavators.
 - Adherence to clearances as directed by other asset owner's instructions and take into account any uncertainty for power cables.
5. You are aware that there are inherent risks and dangers associated with carrying out work in the vicinity of underground facilities (such as **nbn**TM fibre optic, copper and coaxial cables, and power cable feed to **nbn**TM assets). Damage to underground electric cables may result in:
 - Injury from electric shock or severe burns, with the possibility of death.
 - Interruption of the electricity supply to wide areas of the city.
 - Damage to your excavating plant.
 - Responsibility for the cost of repairs.
6. You must take all reasonable precautions to avoid damaging **nbn**TM Facilities. These precautions may include but not limited to the following:
 - All excavation sites should be examined for underground cables by careful hand excavation. Cable cover slabs if present must not be disturbed. Hand excavation needs to be undertaken with extreme care to minimise the likelihood of damage to the cable, for example: the blades of hand equipment should be aligned parallel to the line of the cable rather than digging across the cable.
 - If any undisclosed underground cables are located, notify **nbn** immediately.

- All personnel must be properly briefed, particularly those associated with the use of earth-moving equipment, trenching, boring and pneumatic equipment.
 - The safety of the public and other workers must be ensured.
 - All excavations must be undertaken in accordance with all relevant legislation and regulations.
7. You will be responsible for all damage to **nbn**TM Facilities that are connected whether directly, or indirectly with work you carry out (or work that is carried out for you or on your behalf) at the Location. This will include, without limitation, all losses expenses incurred by **nbn** as a result of any such damage.
 8. You must immediately report any damage to the **nbn**TM network that you are/become aware of. Notification may be by telephone - 1800 626 329.
 9. Except to the extent that liability may not be capable of lawful exclusion, **nbn** and its servants and agents and the related bodies corporate of **nbn** and their servants and agents shall be under no liability whatsoever to any person for any loss or damage (including indirect or consequential loss or damage) however caused (including, without limitation, breach of contract negligence and/or breach of statute) which may be suffered or incurred from or in connection with this information sheet or any plans(including Indicative Plans) attached hereto. Except as expressly provided to the contrary in this information sheet or the attached plans(including Indicative Plans), all terms, conditions, warranties, undertakings or representations (whether expressed or implied) are excluded to the fullest extent permitted by law.

All works undertaken shall be in accordance with all relevant legislations, acts and regulations applicable to the particular state or territory of the Location. The following table lists all relevant documents that shall be considered and adhered to.

State/Territory	Documents
National	Work Health and Safety Act 2011
	Work Health and Safety Regulations 2011
	Safe Work Australia - Working in the Vicinity of Overhead and Underground Electric Lines (Draft)
	Occupational Health and Safety Act 1991
NSW	Electricity Supply Act 1995
	Work Cover NSW - Work Near Underground Assets Guide
	Work Cover NSW - Excavation Work: Code of Practice
VIC	Electricity Safety Act 1998
	Electricity Safety (Network Asset) Regulations 1999
QLD	Electrical Safety Act 2002
	Code of Practice for Working Near Exposed Live Parts
SA	Electricity Act 1996
TAS	Tasmanian Electricity Supply Industry Act 1995
WA	Electricity Act 1945
	Electricity Regulations 1947
NT	Electricity Reform Act 2005
	Electricity Reform (Safety and Technical) Regulations 2005
ACT	Electricity Act 1971

Thank You,

nbn DBYD

Date: 26/04/2023

This document is provided for information purposes only. This document is subject to the information classification set out on this page. If no information classification has been included, this document must be treated as UNCLASSIFIED, SENSITIVE and must not be disclosed other than with the consent of nbn co. The recipient (including third parties) must make and rely on their own inquiries as to the currency, accuracy and completeness of the information contained herein and must not use this document other than with the consent of nbn co.

Copyright © 2021 nbn co Limited. All rights reserved.

To: Canberra Granny Flat Builders
Phone: Not Supplied
Fax: Not Supplied
Email: support@cgfb.com.au

Dial before you dig Job #:	34079195	
Sequence #	223884119	
Issue Date:	26/04/2023	
Location:	14 Macnamara Place , Chisholm , ACT , 2905	

Indicative Plans

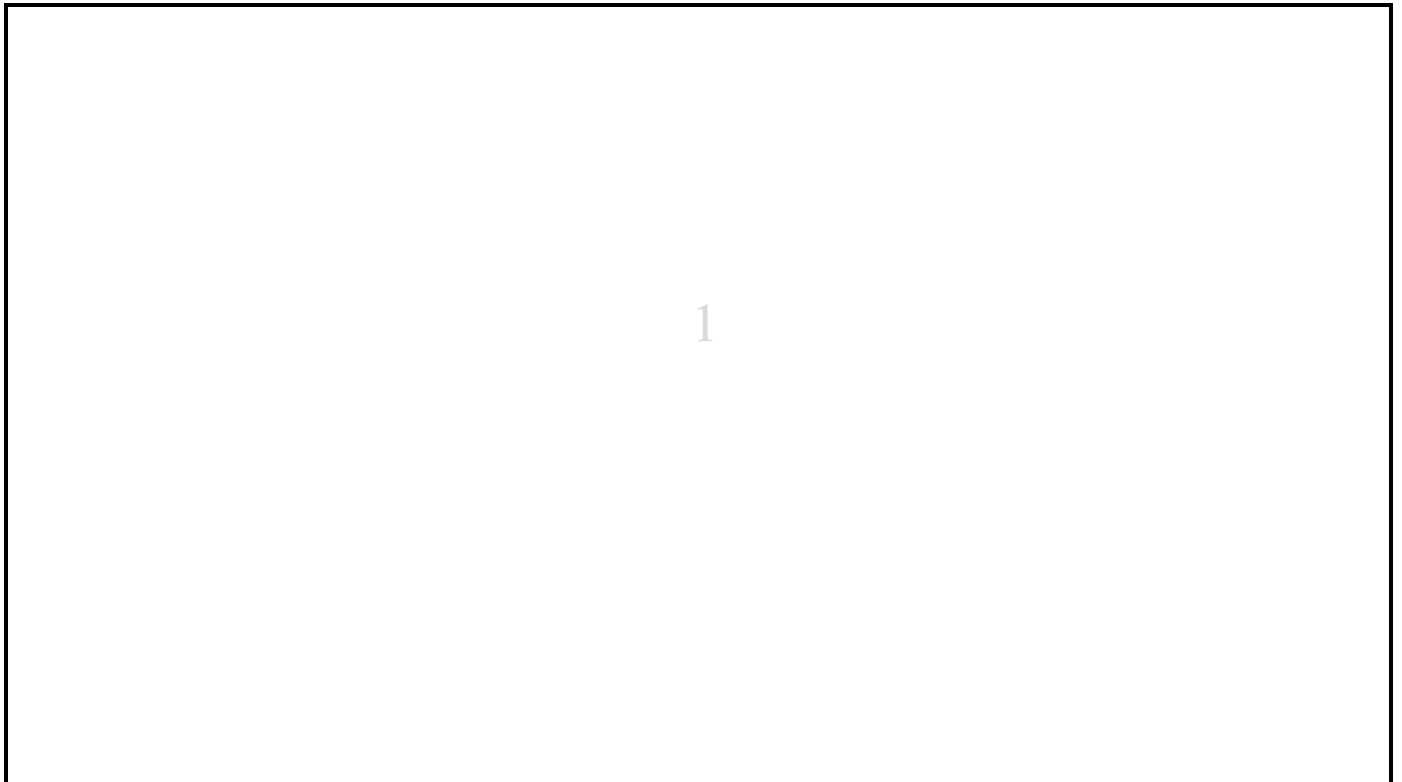



LEGEND



	Parcel and the location
	Pit with size "5"
	Power Pit with size "2E". Valid PIT Size: e.g. 2E, 5E, 6E, 8E, 9E, E, null.
	Manhole
	Pillar
	Cable count of trench is 2. One "Other size" PVC conduit (PO) owned by Telstra (-T-), between pits of sizes, "5" and "9" are 25.0m apart. One 40mm PVC conduit (P40) owned by NBN, between pits of sizes, "5" and "9" are 20.0m apart.
	2 Direct buried cables between pits of sizes, "5" and "9" are 10.0m apart.
	Trench containing any INSERVICE/CONSTRUCTED (Copper/RF/Fibre) cables.
	Trench containing only DESIGNED/PLANNED (Copper/RF/Fibre/Power) cables.
	Trench containing any INSERVICE/CONSTRUCTED (Power) cables.
	Road and the street name "Broadway ST"
Scale	0 20 40 60 Meters 1:2000 1 cm equals 20 m

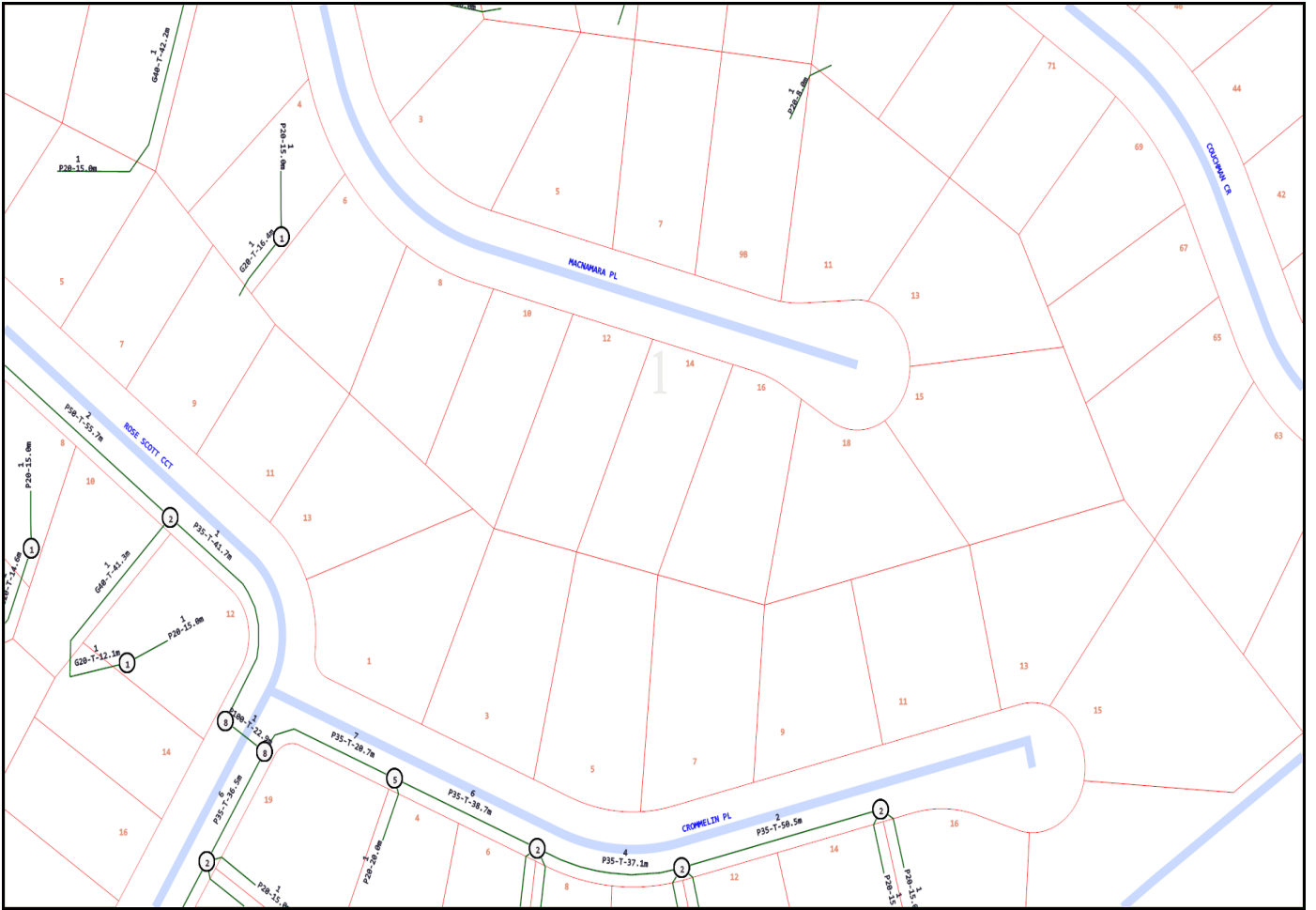

Emergency Contacts

You must immediately report any damage to the **nbn™** network that you are/become aware of. Notification may be by telephone - 1800 626 329.



Certified Locating Organisations (CLO)

Find the closest CLO to your worksite on: <https://dbydlocator.com/certified-locating-organisation/>

Read the disclaimer and click:

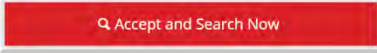

A national map and an A-Z list of Certified Locating Organisations is displayed.



Search ZIP code: Radius:

Use the map to zoom to your work area and choose the closest Locator indicated.

OR search by entering the **postcode** of your work area.

1. Enter the post/zip code
2. Choose your search radius
3. Click filter (If there is no result, you may have to increase the search radius)
4. Click on the closest for CLO details or view the results displayed below the map

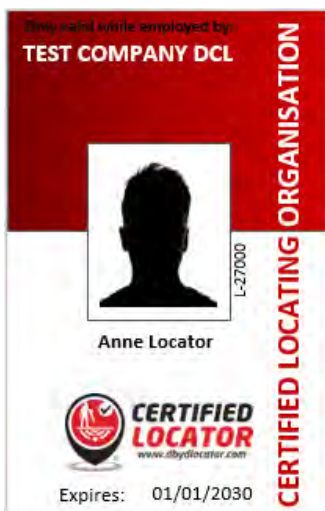

Locator skills have been tested, and the Organisation has calibrated location and safety equipment.

Telstra is aware of each Certified Locating Organisation and their employee locators.

Only a DBYD Certified Locator registered with a Certified Locating Organisation is authorised to access Telstra network for locating purposes.

Each Certified Locator working for a CLO is issued with a photo ID Card, authorising them to access Telstra pits and manholes for the purpose of cable and plant locations.

Please ask to see your Locators' CLO ID Card.

Cable Plan

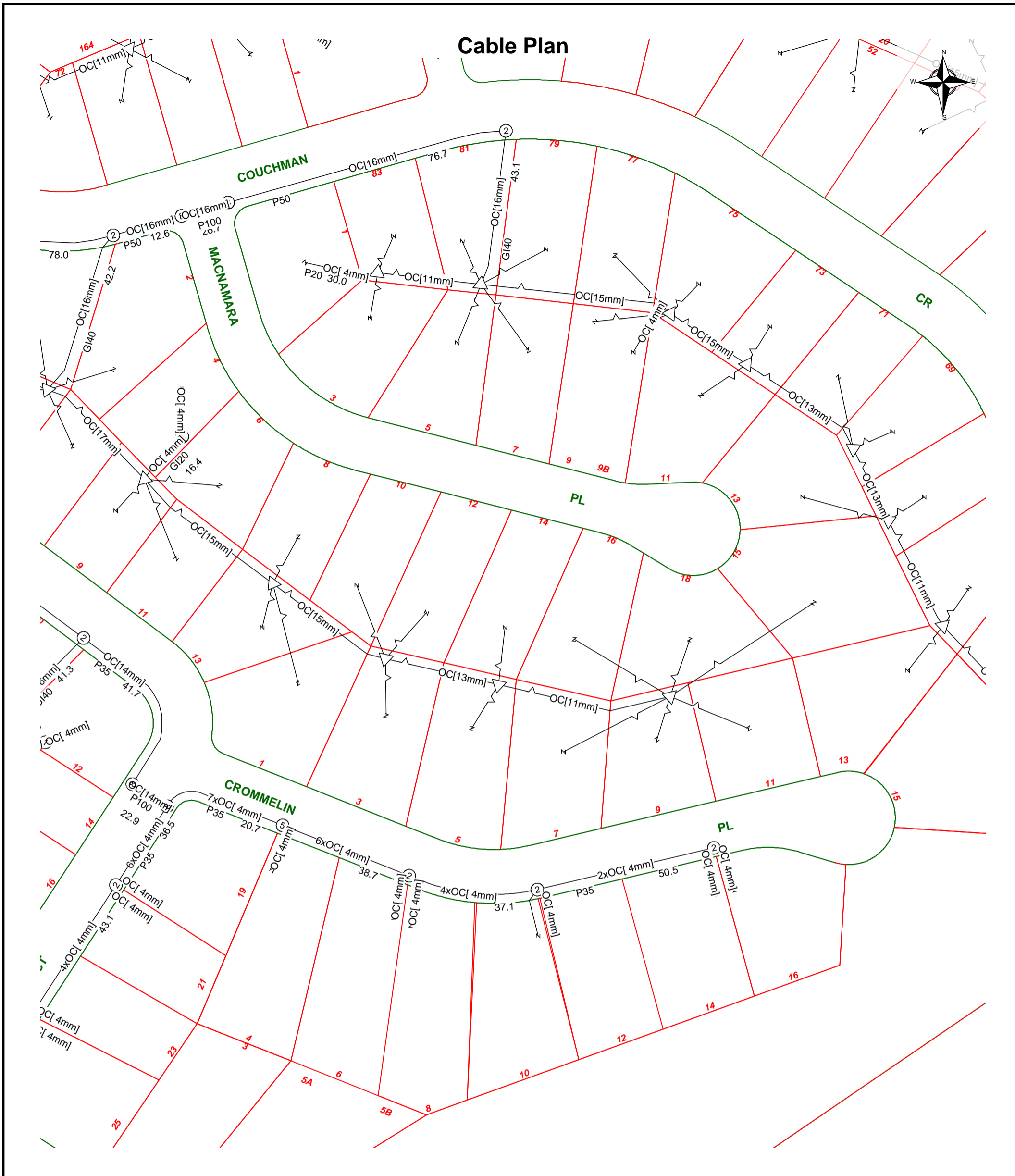

Report Damage: <https://service.telstra.com.au/customer/general/forms/report-damage-to-telstra-equipment>
 Ph - 13 22 03
 Email - Telstra.Plans@team.telstra.com
 Planned Services - ph 1800 653 935 (AEST bus hrs only) General Enquiries

Sequence Number: 223884118

Please read Duty of Care prior to any excavating

TELSTRA LIMITED A.C.N. 086 174 781

Generated On 26/04/2023 19:07:45

WARNING
 Telstra plans and location information conform to Quality Level "D" of the Australian Standard AS 5488-Classification of Subsurface Utility Information. As such, Telstra supplied location information is indicative only. Spatial accuracy is not applicable to Quality Level D. Refer to AS 5488 for further details. The exact position of Telstra assets can only be validated by physically exposing it. Telstra does not warrant or hold out that its plans are accurate and accepts no responsibility for any inaccuracy. Further on site investigation is required to validate the exact location of Telstra plant prior to commencing construction work. A Certified Locating Organisation is an essential part of the process to validate the exact location of Telstra assets and to ensure the asset is protected during construction works.

See the Steps- Telstra Duty of Care that was provided in the email response.



OPENING ELECTRONIC MAP ATTACHMENTS -

Telstra Cable Plans are generated automatically in either PDF or DWF file types dependant on the site address and the size of area selected. You may need to download and install free viewing software from the internet e.g.

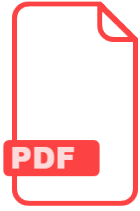

PDF Map Files (max size A3)

Adobe Acrobat Reader (<http://get.adobe.com/reader/>),



DWF Map Files (all sizes over A3)

Autodesk Viewer (Browser) (<https://viewer.autodesk.com/>) or

Autodesk Design Review (<http://usa.autodesk.com/design-review/>) for DWF files.
(Windows)



Telstra DBYD map related enquiries

email - Telstra.Plans@team.telstra.com

1800 653 935 (AEST Business Hours only)



REPORT ANY DAMAGE TO THE TELSTRA NETWORK IMMEDIATELY

Report online - <https://service.telstra.com.au/customer/general/forms/report-damage-to-telstra-equipment>

Ph: 13 22 03

If you receive a message asking for a phone or account number say:

"I don't have one" then say "Report Damage" then press 1 to speak to an operator.



Telstra New Connections / Disconnections

13 22 00

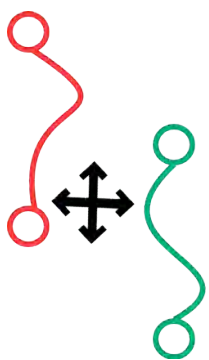

Telstra asset relocation enquiries: 1800 810 443 (AEST business hours only).

NetworkIntegrity@team.telstra.com

<https://www.telstra.com.au/consumer-advice/digging-construction>

Certified Locating Organisation (CLO)

<https://dbydlocator.com/certified-locating-organisation/>



Please refer to attached Accredited Plant Locator.pdf

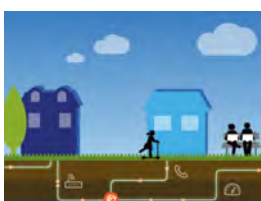











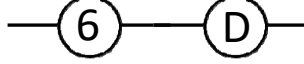

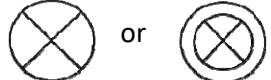

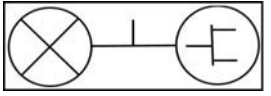

Telstra Smart Communities

Information for new developments (developers, builders, homeowners)

<https://www.telstra.com.au/smart-community>

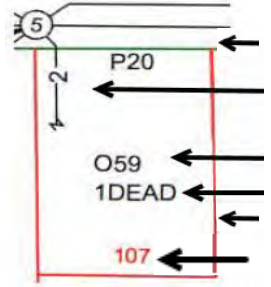
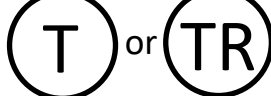
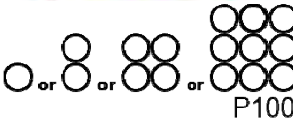
LEGEND

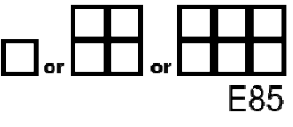
For more info contact a [Certified Locating Organisation](#) or Telstra Plan Services 1800 653 935

	Exchange (Major Cable Present)		Cable Jointing Pit (number / Letter indicating Pit Type)
	Footway Access Chamber (can vary from 1-lid to 12-lid)		Elevated Joint (above ground joint on buried cable)
	Pillar / Cabinet (above ground / free standing)		Telstra Plant in shared Utility trench
	Above ground complex equipment housing (eg RIM) Please Note: This equipment is powered by 240V Electricity		Aerial Cable
	Other Carrier Telecommunications Cable/Asset		Aerial Cable (attached to joint Use Pole eg. Power)
	Distribution cables in Main Cable ducts		Direct Buried Cable
	Main Cable ducts on a Distribution plan Blocked or damaged duct.		Marker Post Installed
	Roadside / Front Boundary 2 pair lead-in to property from pit in street 1 O59 ← pair working (pair ID 059) 1DEAD ← 1 pair dead (i.e. spare, not connected) Side / Rear Property Boundary Property Number 107		Buried Transponder
	Single to multiple round conduit Configurations 1,2,4,9 respectively (attached text denotes conduit type and size)		Marker Post, Transponder
	Multiple square conduit Configurations 2, 4, 6 respectively (attached text denotes conduit type and size)		Optical Fibre cable direct buried

Some examples of conduit type and size:

A - Asbestos cement, P - PVC / Plastic, C - Concrete,
GI - Galanised iron, E - Earthenware
Conduit sizes *nominally* range from 20mm to 100mm
P50 50mm PVC conduit
P100 100mm PVC conduit
A100 100mm asbestos cement conduit

Some Examples of how to read Telstra Plans

One 50mm PVC conduit (P50) containing a 50-pair and a 10-pair cable between two 6-pits. approximately 20.0m apart, with a direct buried 30-pair cable along the same route

Two separate conduit runs between two footway access chambers (manholes) approximately 245m apart A nest of four 100mm PVC conduits (P100) containing assorted cables in three ducts (one being empty) and one empty 100mm concrete duct (C100) along

WARNING: Telstra plans and location information conform to Quality Level 'D' of the Australian Standard AS 5488 - Classification of Subsurface Utility Information. As such, Telstra supplied location information is indicative only. Spatial accuracy is not applicable to Quality Level D. Refer to AS 5488 for further details. Telstra does not warrant or hold out that its plans are accurate and accepts no responsibility for any inaccuracy shown on the plans. FURTHER ON SITE INVESTIGATION IS REQUIRED TO VALIDATE THE EXACT LOCATION OF TELSTRA PLANT PRIOR TO COMMENCING CONSTRUCTION WORK. A plant location service is an essential part of the process to validate the exact location of Telstra assets and to ensure the assets are protected during construction works. The exact position of Telstra assets can only be validated by physically exposing them. Telstra will seek compensation for damages caused to its property and losses caused to Telstra and its customers.

Before You Dig Australia

Think before you dig

This document has been sent to you because you requested plans of the Telstra network through Before You Dig Australia (BYDA).

If you are working or excavating near telecommunications cables, or there is a chance that cables are located near your site, you are responsible to avoid causing damage to the Telstra network.

Please read this document carefully. Taking your time now and following the steps below can help you avoid damaging our network, interrupting services, and potentially incurring civil and criminal penalties.

Our network is complex and working near it requires expert knowledge. Do not attempt these activities if you are not qualified to do so.



1. Plan

Plan your work with the latest plans of our network.

Plans provided through the BYDA process are indicative only*.

This means the actual location of our asset may differ substantially from that shown on the plans.

Refer to steps 2 and 3 to determine actual location prior to proceeding with construction.



2. Prepare

Engage a DBYD Certified Locating Organisation (CLO) via dbylocator.com to identify, validate and protect Telstra assets before you commence work.



3. Pothole

Validate underground assets by potholing by hand or using non-destructive vacuum extraction methods.

Electronic detection alone (step 2) is not deemed to validate underground assets and must not be used for construction purposes.

If you cannot validate the Telstra network, you must not proceed with construction.



4. Protect

Protect our network by maintaining the following distances from our assets:

- › 1.0m Mechanical Excavators, Farm Ploughing, Tree Removal
- › 500mm Vibrating Plate or Wacker Packer Compactor
- › 600mm Heavy Vehicle Traffic (over 3 tonnes) not to be driven across Telstra ducts or plant
- › 1.0m Jackhammers/Pneumatic Breakers
- › 2.0m Boring Equipment (in-line, horizontal and vertical)



5. Proceed

You can proceed with your work only once you have completed all the appropriate preparation, potholing and protection.

Report any damage immediately



<https://service.telstra.com.au/customer/general/forms/report-damage-to-telstra-equipment>



13 22 03

If you receive a message asking for an account or phone number say "I Don't have one" Then say "Report Damage" then press 1 to speak to an operator.

Relocating assets

If your project requires the relocation of a Telstra asset, please contact the Telstra Network Integrity Group:



[Request Asset Relocation Or Commercial Works \(telstra.com.au\)](https://telstra.com.au)



NetworkIntegrity@team.telstra.com



1800 810 443 (AEST business hours only)

Never try to move or alter our network infrastructure without authorisation. By law, only authorised people can work on our assets or enter a facility owned or operated by us. Any interference, including unauthorised entry or tampering, may result in legal action.

Further information

Plan enquiries



1800 653 935 (AEST business hours only)



Telstra.Plans@team.telstra.com

Information on how to find cables and request asset relocations:

<https://www.telstra.com.au/consumer-advice/digging-construction>

Asset Plan Readers

PDF [Adobe Acrobat Reader DC Install for all versions](#)

DWF [Download Design Review | DWF Viewer | Autodesk](#)

Disclaimer and legal details



*Telstra advises that the accuracy of the information provided by Telstra conforms to Quality Level D as defined in AS5488-2013.

It is a criminal offence under the Criminal Code Act 1995 (Cth) to tamper or interfere with telecommunications infrastructure.

Telstra will also take action to recover costs and damages from persons who damage assets or interfere with the operation of Telstra's networks.

By receiving this information including the indicative plans that are provided as part of this information package you confirm that you understand and accept the risks of working near Telstra's network and the importance of taking all of the necessary steps to confirm the presence, alignments and various depths of Telstra's network. This in addition to, and not in replacement of, any duties and obligations you have under applicable law.

When working in the vicinity of a telecommunications plant you have a "Duty of Care" that must be observed. Please read and understand all the information and disclaimers provided below.

The Telstra network is complex and requires expert knowledge to interpret information, to identify and locate components, to pothole underground assets for validation and to safely work around assets without causing damage. If you are not an expert and/or qualified in these areas, then you must not attempt these activities. Telstra will seek compensation for damages caused to its property and losses caused to Telstra and its customers. The 5 P's to prevent damage to Telstra assets are listed above. Construction activities and/or any activities that potentially may impact on Telstra's assets must not commence without first undertaking these steps. Construction activities can include anything that involves breaking ground, potentially affecting Telstra assets.

If you are designing a project, it is recommended that you also undertake these steps to validate underground assets prior to committing to your design.

This Notice has been provided as a guide only and may not provide you with all the information that is required for you to determine what assets are on or near your site of interest. You will also need to collate and understand all of the information received from other Utilities and understand that some Utilities are not a part of the BYDA program and make your own enquiries as appropriate. It is the responsibility of the entities undertaking the works to protect Telstra's network during excavation / construction works.

Telstra owns and retains the copyright in all plans and details provided in conjunction with the applicant's request. The applicant is authorised to use the plans and details only for the purpose indicated in the applicant's request. The applicant must not use the plans or details for any other purpose.

Telstra plans or other details are provided only for the use of the applicant, its servants, agents, or Certified Locating Organisation. The applicant must not give the plans or details to any parties other than these and must not generate profit from commercialising the plans or details.

Telstra, its servants or agents shall not be liable for any loss or damage caused or occasioned by the use of plans and or details so supplied to the applicant, its servants and agents, and the applicant agrees to indemnify Telstra against any claim or demand for any such loss or damage.

Please ensure Telstra plans and information provided always remains on-site throughout the inspection, location, and construction phase of any works.

Telstra plans are valid for 60 days after issue and must be replaced if required after the 60 days.

Data Extraction Fees

In some instances, a data extraction fee may be applicable for the supply of Telstra information. Typically, a data extraction fee may apply to large projects, planning and design requests or requests to be supplied in non-standard formats. For further details contact Telstra Planned Services.

Telstra does not accept any liability or responsibility for the performance of or advice given by a Certified Locating Organisation. Certification is an initiative taken by Telstra towards the establishment and maintenance of competency standards. However, performance and the advice given will always depend on the nature of the individual engagement.

Neither the Certified Locating Organisation nor any of its employees are an employee or agent for Telstra. Telstra is not liable for any damage or loss caused by the Certified Locating Organisation or its employees.

Once all work is completed, the excavation should be reinstated with the same type of excavated material unless specified by Telstra

The information contained within this pamphlet must be used in conjunction with other material supplied as part of this request for information to adequately control the risk of potential asset damage.

When using excavators and other machinery, also check the location of overhead power lines.

Workers and equipment must maintain safety exclusion zones around power lines

WARNING: Telstra plans and location information conform to Quality Level 'D' of the Australian Standard AS 5488 - Classification of Subsurface Utility Information. As such, Telstra supplied location information is indicative only. Spatial accuracy is not applicable to Quality Level D. Refer to AS 5488 for further details. Telstra does not warrant or hold out that its plans are accurate and accepts no responsibility for any inaccuracy shown on the plans. **FURTHER ON SITE INVESTIGATION IS REQUIRED TO VALIDATE THE EXACT LOCATION OF TELSTRA PLANT PRIOR TO COMMENCING CONSTRUCTION WORK.** A plant location service is an essential part of the process to validate the exact location of Telstra assets and to ensure the assets are protected during construction works. The exact position of Telstra assets can only be validated by physically exposing them. Telstra will seek compensation for damages caused to its property and losses caused to Telstra and its customers.

Privacy Note

Your information has been provided to Telstra by BYDA to enable Telstra to respond to your BYDA request. Telstra keeps your information in accordance with its privacy statement. You can obtain a copy at www.telstra.com.au/privacy or by calling us at 1800 039 059 (business hours only).



ACT
Government

Transport Canberra and
City Services

Before You Dig (BYDA) Location Information

Asset owner

Transport Canberra and City Services
GPO Box 158
Fyshwick ACT 2601

Service provider

Streetlighting Unit
Roads ACT
Transport Canberra and City Services
PO Box 158
Fyshwick ACT 2601

To:

Canberra Granny Flat Builders
Unit 6, Level 2, 80 Emu Bank
Belconnen ACT 2617

Enquiry Details

Utility ID	90520
Job Number	34079195
Sequence Number	223884121
Enquiry Date	26 April 2023
Response	AFFECTED
Address	14 Macnamara Place Chisholm ACT 2905
Location in Road	
Activity	Mechanical Excavation

Enquirer Details

Customer ID	3025791
Contact	Canberra Granny Flat Builders
Company	Not supplied
Email	support@cgfb.com.au
Phone	+611300979658

Disclaimer

PLEASE READ ALL THE INFORMATION AND DISCLAIMERS PROVIDED ON THE ATTACHED PAGES

General location only

- The approximate location of Street Light Network assets (**the Assets**) in the nominated area are shown on the attached maps (**the Asset Plan**).
- The Asset locations provided with this response are based on the information available at the time and are only an indication of the presence of Assets within the nominated location. If the nominated area is not what you require, please resubmit another inquiry.
- The Asset Plans provided do not show the presence of any other assets, including private property assets.
- Please be aware that the location of the Assets may change to those indicated on the Asset Plan. The Asset locations shown on the attached Asset Plan are indicative only. Due to changes in surface levels and surrounding infrastructure, and works undertaken by other parties, Asset location may differ to those shown on the Asset Plan.
- *It is your responsibility to verify the location of the Assets shown on the Asset Plan through positive identification process*
- A new Asset Plan should be obtained every 28 days to ensure currency and accuracy. It is your responsibility to obtain a new Asset Plan if required.
- While every endeavour has been made to provide information that is accurate and reliable, complete accuracy cannot be guaranteed. Transport Canberra and City Services (TCCS) does not represent or warrant that you or any user of the Asset Plan will achieve any particular objective or guarantee any outcome.

Limitation of Liability

To the maximum extent permitted by law, TCCS and its officers, employees, contractors and agents accept no liability and are not responsible for any actions, liabilities, losses, damages (including consequential damages), costs, claims or expenses of whatever nature and regardless of the cause of action, whether in contract, tort (including negligence) or otherwise, arising out of or in connection with or as a consequence of any inaccuracies in the Asset Plan or the use of the information contained in the Asset Plan.

Without limiting the above, TCCS and its officers, employees, contractors and agents are not responsible to any person for:

- (a) The currency, accuracy or completeness of the information provided in the Asset Plan; or
- (b) Any delays in respect of delivery or supply by TCCS of the information sought in connection with the location of the Assets.



To the maximum extent permitted by law, TCCS specifically excludes any conditions, terms or warranties that may be implied into, or in respect of the provision of the Asset Plan and to the extent that any such condition, term or warranty or liability cannot be excluded, TCCS liability for breach of such implied term, condition or warranty is limited to the resupply of the Asset Plan provided by TCCS or the payment of the reasonable costs of having the Asset Plan supplied again.

Work to be carried out without interference or damage to Assets

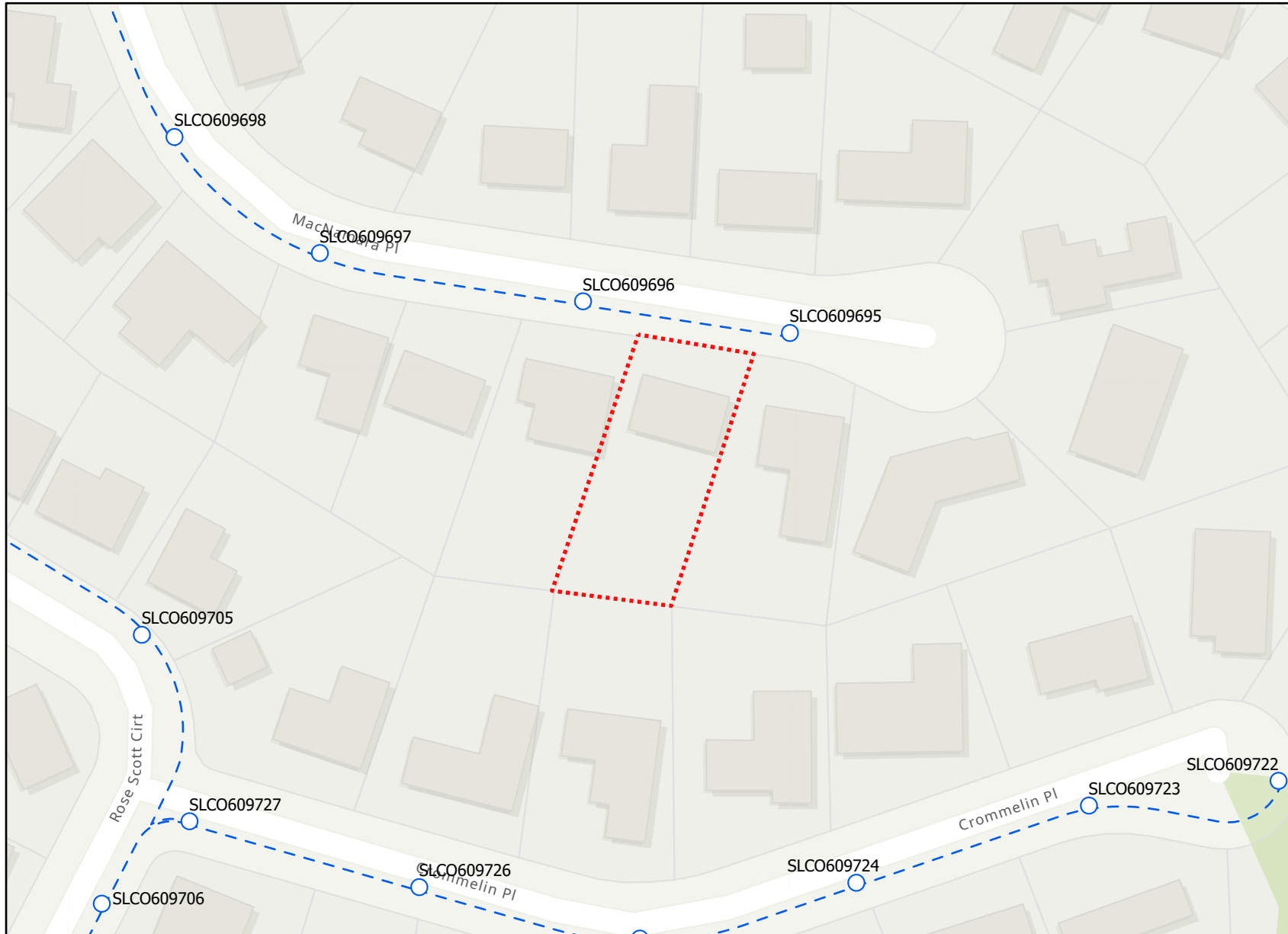
Any work undertaken near the Assets, must be performed in a way that does not interfere with the reliability of or access to the Assets. Any work carried out that includes changing the surface level in any area where Assets are indicated must be carried out with care and you will be responsible for any damage caused through failure to exercise such care. TCCS may pursue the person or organisation responsible for causing any damage or interference to the Assets.



Legend

-  BYDA Enquiry
- Streetlighting Infrastructure
 -  Streetlight
 -  Underground Cable - In Service

Disclaimer: The Plan is provided in response to a Before You Dig request. While all reasonable care has been taken to ensure the accuracy of the information on this plan, its purpose is to provide a general indication of the location of Transport Canberra and City Services infrastructure. The information provided may contain errors or omissions and the accuracy may not suit all users. A site inspection and investigation is recommended before commencement of any project based on this data.

In an emergency contact Transport Canberra and City Services on (02) 7801 3960

26/04/23 (valid for 30 days)

Plans generated by SmarterWX™ Automate

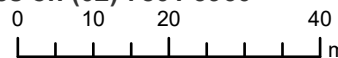

Scale 1:1,000

Example plans that we will create during the custom and modification design process



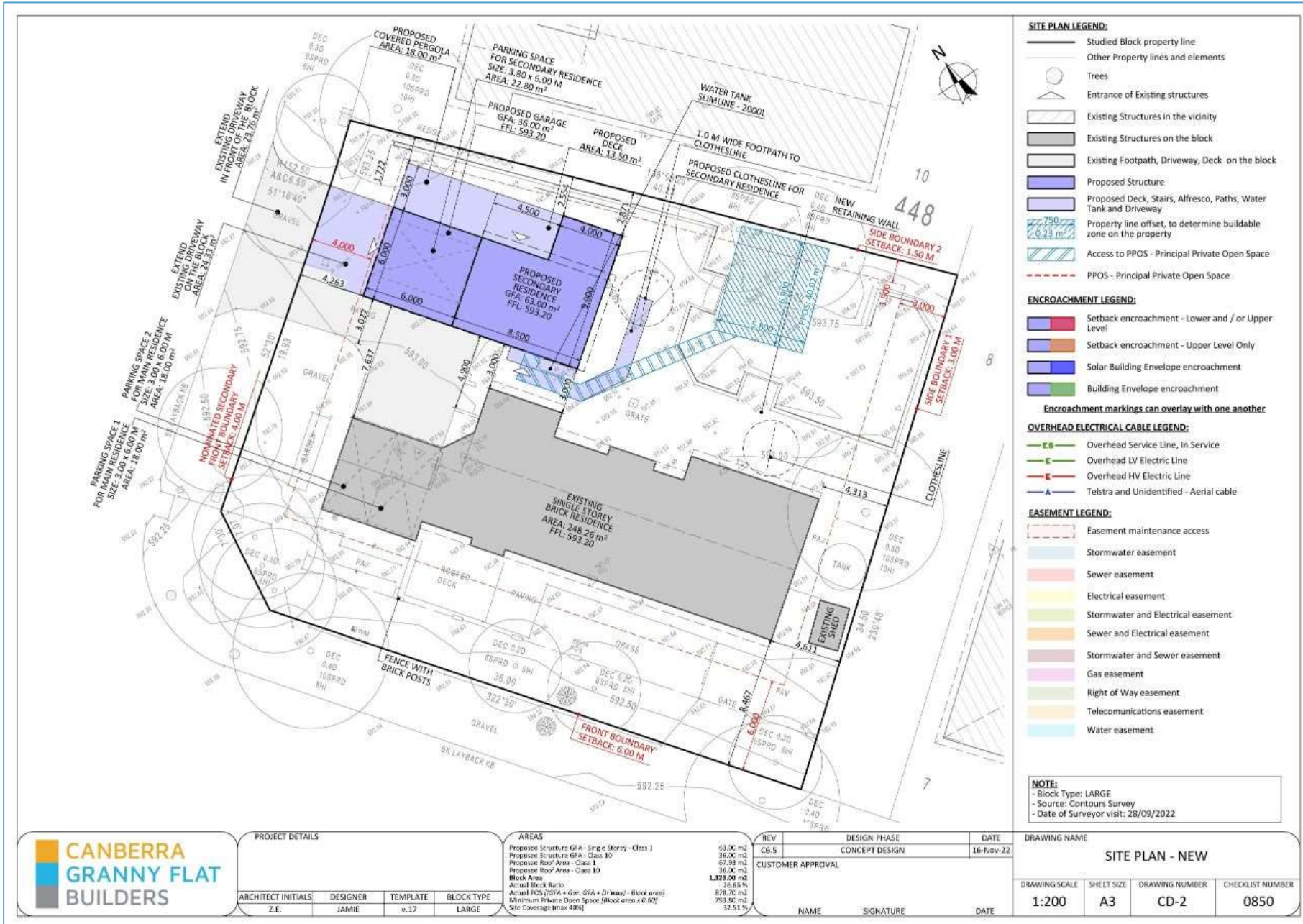

PROJECT DETAILS			
ARCHITECT INITIALS	DESIGNER	TEMPLATE	BLOCK TYPE
Z.E.	JAMIE	v.17	LARGE

AREAS	
Proposed Structure GFA - Single Storey - Class 1	63.00 m ²
Proposed Structure GFA - Class 10	36.00 m ²
Proposed Roof Area - Class 1	67.53 m ²
Proposed Roof Area - Class 10	36.00 m ²
Block Area	1,323.00 m²
Actual Block Ratio	26.85%
Actual PPOS (GFA + Gar. GFA + Driveway) - Block area)	878.70 m ²
Minimum Private Open Space (Block area x 0.60)	793.80 m ²
Site Coverage (Max 40%)	52.51%

REV	DESIGN PHASE	DATE
06.5	CONCEPT DESIGN	16-Nov-22

CUSTOMER APPROVAL		
NAME	SIGNATURE	DATE

DRAWING NAME			
SITE PLAN - NEW			
DRAWING SCALE	SHEET SIZE	DRAWING NUMBER	CHECKLIST NUMBER
1:200	A3	CD-2	0850

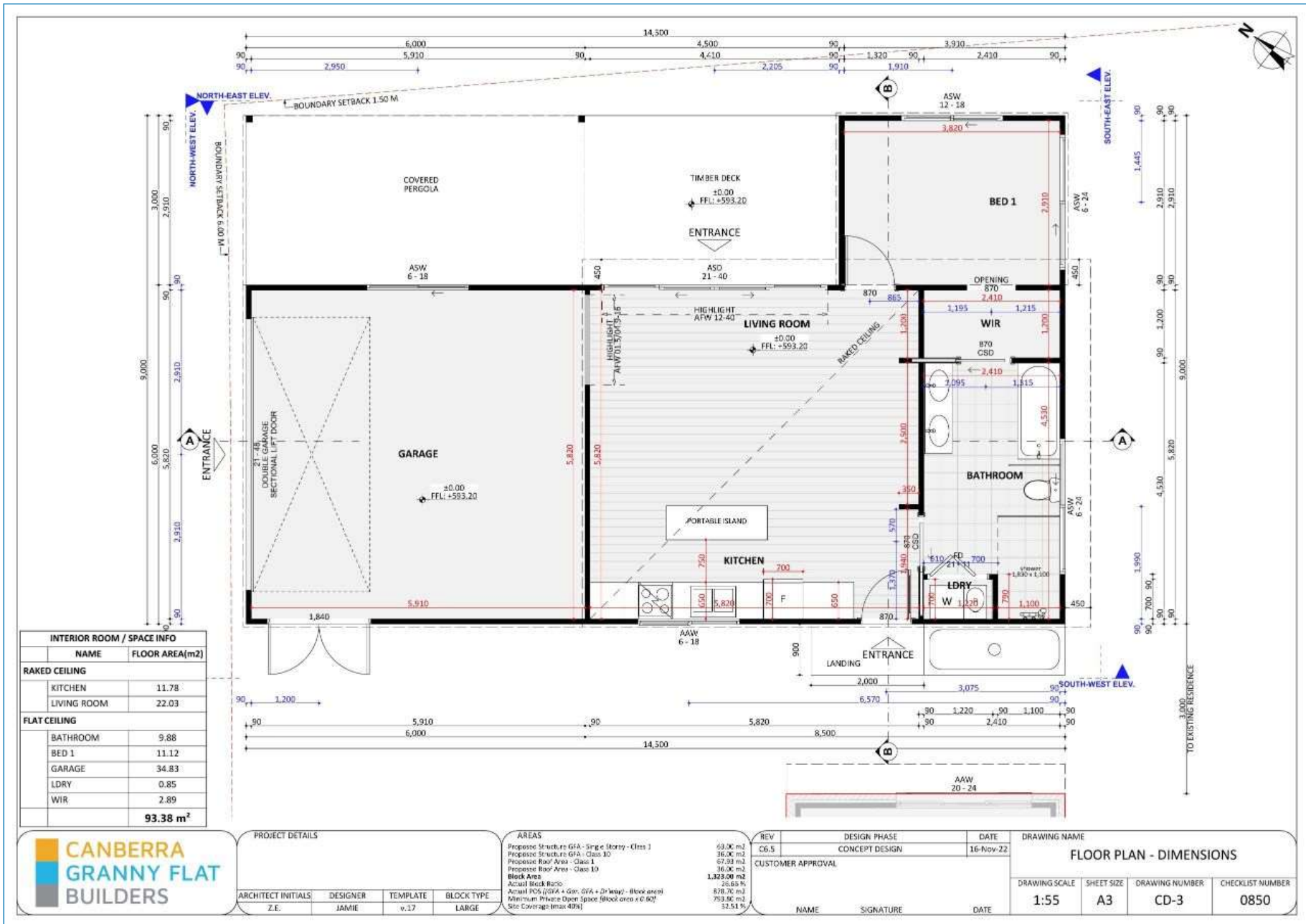

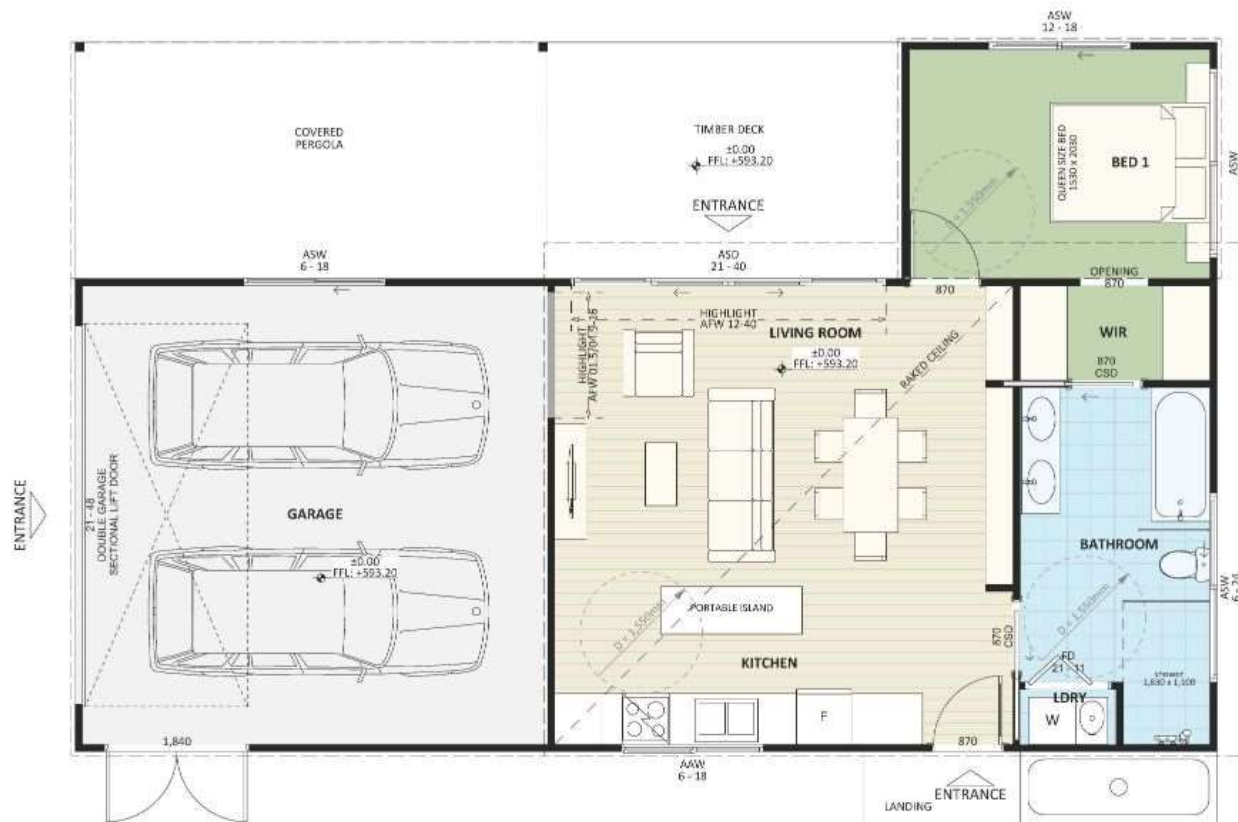

PROJECT DETAILS			
ARCHITECT INITIALS	DESIGNER	TEMPLATE	BLOCK TYPE
Z.E.	JAMIE	v.17	LARGE

AREAS	
Proposed Structure GFA - Single Storey - Class 3	63.00 m ²
Proposed Structure GFA - Class 10	26.00 m ²
Proposed Roof Area - Class 3	67.50 m ²
Proposed Roof Area - Class 10	36.00 m ²
Block Area	1,323.00 m²
Actual Block Ratio	26.85 %
Actual PCS (GFA + Gar. GFA + Driveway) - Block area	878.70 m ²
Minimum Private Open Space (Block area x 0.60)	793.80 m ²
Site Coverage (max 40%)	52.51 %

REV	DESIGN PHASE	DATE
06.5	CONCEPT DESIGN	16-Nov-22

CUSTOMER APPROVAL		
NAME	SIGNATURE	DATE

DRAWING NAME			
FLOOR PLAN - FURNITURE			
DRAWING SCALE	SHEET SIZE	DRAWING NUMBER	CHECKLIST NUMBER
1:55	A3	CD-4	0850

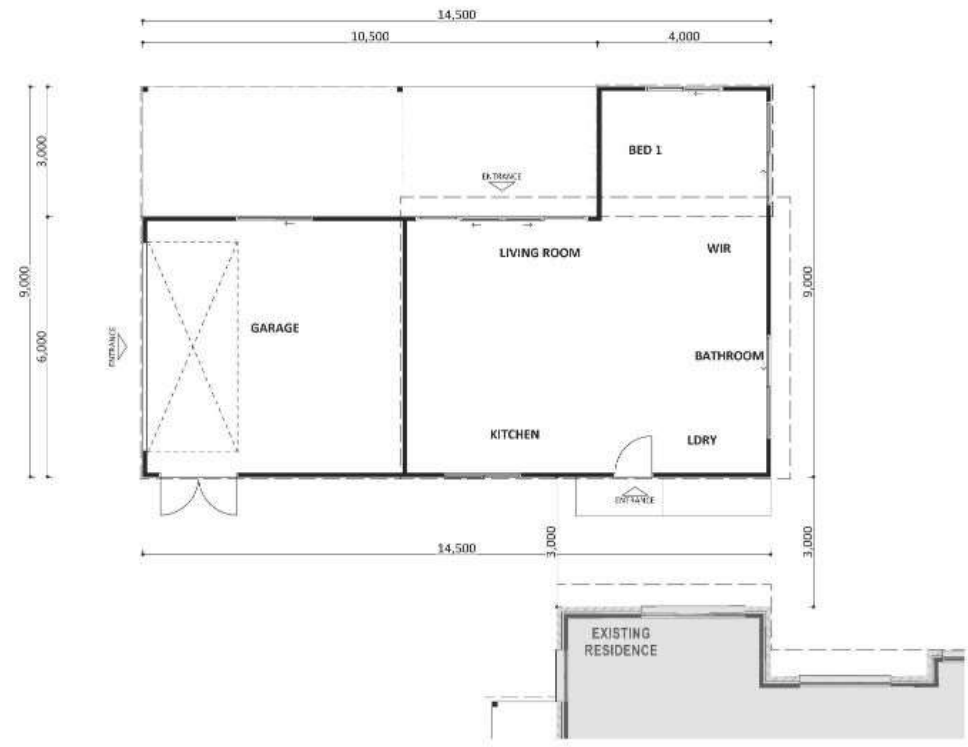

PROJECT DETAILS			
ARCHITECT INITIALS	DESIGNER	TEMPLATE	BLOCK TYPE
Z.E.	JAMIE	v.17	LARGE

AREAS	
Proposed Structure GFA - Single Storey - Class 3	63.00 m ²
Proposed Structure GFA - Class 10	26.00 m ²
Proposed Roof Area - Class 1	67.50 m ²
Proposed Roof Area - Class 10	36.00 m ²
Block Area	1,323.00 m²
Actual Block Ratio	26.85%
Actual FOS (GFA + Gar. GFA + Driveway) - Block area	878.70 m ²
Minimum Private Open Space (Block area x 0.60)	793.80 m ²
Site Coverage (max 40%)	52.51%

REV	DESIGN PHASE	DATE
06.5	CONCEPT DESIGN	16-Nov-22

CUSTOMER APPROVAL		
NAME	SIGNATURE	DATE

DRAWING NAME			
PUBLIC REGISTER			
DRAWING SCALE	SHEET SIZE	DRAWING NUMBER	CHECKLIST NUMBER
1:100	A3	CD-5	0850

NOTE:
 - Source: Contours Survey
 - Date of Site Inspection visit: 20/03/2022
 - Date of Surveyor visit: 28/09/2022
 - For Solar Envelope and Building Envelope, see drawing:
 "SOLAR AND BUILDING ENVELOPE"



NORTH-EAST ELEV.



SOUTH-WEST ELEV.



PROJECT DETAILS			
ARCHITECT INITIALS	DESIGNER	TEMPLATE	BLOCK TYPE
Z.E.	JAMIE	v.17	LARGE

AREAS	
Proposed Structure GFA - Single Storey - Class 1	69.00 m ²
Proposed Structure GFA - Class 10	36.00 m ²
Proposed Roof Area - Class 1	67.93 m ²
Proposed Roof Area - Class 10	36.00 m ²
Block Area	1,329.00 m²
Actual Block Ratio	26.85 %
Actual PCS (GFA + Gar. GFA + Driveway) - Block area	878.70 m ²
Minimum Private Open Space (Block area x 0.60)	753.60 m ²
Site Coverage (Max 40%)	52.51 %

REV	DESIGN PHASE	DATE
C6.5	CONCEPT DESIGN	16-Nov-22

CUSTOMER APPROVAL		
NAME	SIGNATURE	DATE

DRAWING NAME			
ELEVATIONS 1			
DRAWING SCALE	SHEET SIZE	DRAWING NUMBER	CHECKLIST NUMBER
1:55	A3	CD-6	0850

NOTE:
 - Source: Contours Survey
 - Date of Site Inspection visit: 20/03/2022
 - Date of Surveyor visit: 28/09/2022
 - For Solar Envelope and Building Envelope, see drawing: "SOLAR AND BUILDING ENVELOPE"

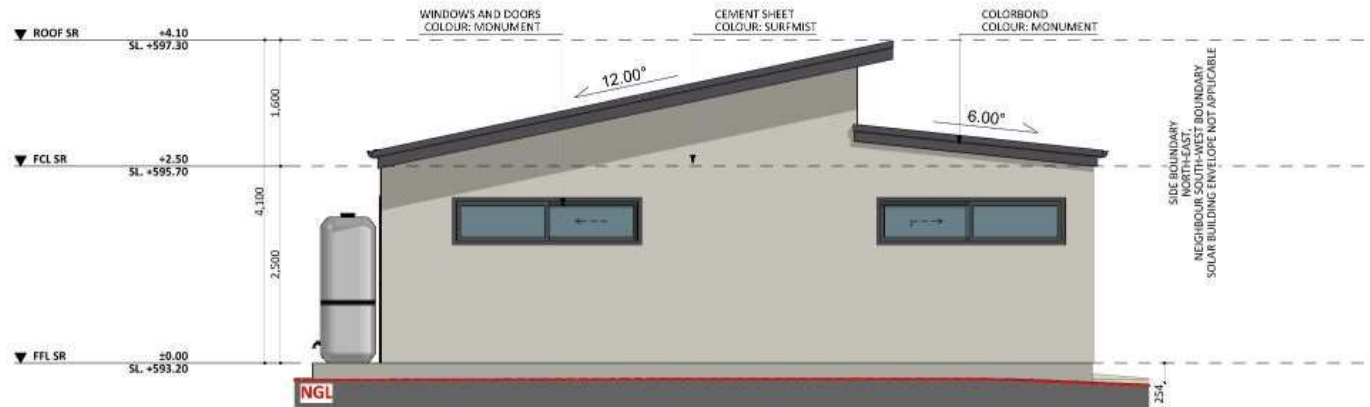

E3 SOUTH-EAST ELEV.



E4 NORTH-WEST ELEV.



PROJECT DETAILS			
ARCHITECT INITIALS	DESIGNER	TEMPLATE	BLOCK TYPE
Z.E.	JAMIE	v.17	LARGE

AREAS	
Proposed Structure GFA - Single Storey - Class 1	69.00 m ²
Proposed Structure GFA - Class 10	36.00 m ²
Proposed Roof Area - Class 1	67.53 m ²
Proposed Roof Area - Class 10	36.00 m ²
Block Area	1,329.00 m²
Actual Block Ratio	26.85 %
Actual PCS (GFA + Gar. GFA + Driveway) - Block area	878.70 m ²
Minimum Private Open Space (Block area x 0.60)	753.90 m ²
Site Coverage (Max 40%)	52.51 %

REV	DESIGN PHASE	DATE
C6.5	CONCEPT DESIGN	16-Nov-22

CUSTOMER APPROVAL		
NAME	SIGNATURE	DATE

DRAWING NAME			
ELEVATIONS 2			
DRAWING SCALE	SHEET SIZE	DRAWING NUMBER	CHECKLIST NUMBER
1:55	A3	CD-7	0850



Notes

Actual plot ratio = $\frac{\text{Existing building(s)/structure(s)} + \text{Proposed new building(s)/structures}}{\text{Site area}} \times 100$

Actual private open space = Site area - (Existing building(s)/structure(s) + Proposed new building(s)/structure(s) + Driveways and maneuvering space)

Planting area = Actual private open space - Non planting area

LEGEND	PLOT RATIO	PRIVATE OPEN SPACE
A.0.1 SITE AREA - TOTAL	1,323.00 m ²	1,323.00 m ²
A.1 EXISTING BUILDING(S) / STRUCTURE(S)	253.75 m ²	253.75 m ²
A.2 PROPOSED NEW BUILDING(S)/STRUCTURE(S)	99.00 m ²	99.00 m ²
A.3 DRIVEWAYS AND MANEUVERING SPACE	N/A	91.55 m ²
	ACTUAL PLOT RATIO = 26.66% (MAXIMUM PLOT RATIO = 50%)	ACTUAL PRIVATE OPEN SPACE = 878.70 m ² (MINIMUM POS = [SITE AREA X 60%] = 793.80 m ²)
A.4 NON PLANTING AREA	N/A	335.13 m ²
A.5 PLANTING AREA	N/A	ACTUAL PLANTING AREA: 543.57 m ² 41.08 % MINIMUM PLANTING AREA [SITE AREA X 30%]: 396.90 m ² 30 %
A.5 PPOS	N/A	40.00 m ²



PROJECT DETAILS

ARCHITECT INITIALS:	DESIGNER:	TEMPLATE:	BLOCK TYPE:
Z.E.	JAMIE	v.17	LARGE

AREAS

Proposed Structure GFA - Single Storey - Class 3
 Proposed Structure GFA - Class 10
 Proposed Roof Area - Class 1
 Proposed Roof Area - Class 10
Block Area
 Actual Block Ratio
 Actual POS (GFA + Gar. GFA + Driveway) - Block area
 Minimum Private Open Space (Block area x 60%)
 Site Coverage (Max 40%)

63.00 m²
 26.00 m²
 67.50 m²
 36.00 m²
1,323.00 m²
 26.66 %
 878.70 m²
 793.80 m²
 32.51 %

REV	DESIGN PHASE	DATE
06.5	CONCEPT DESIGN	16-Nov-22
CUSTOMER APPROVAL		
NAME	SIGNATURE	DATE

DRAWING NAME

AREA PLAN

DRAWING SCALE	SHEET SIZE	DRAWING NUMBER	CHECKLIST NUMBER
1:200	A3	CD-8	0850

Adaptable Housing to AS 4299
Features to be included post adaptation

Siting

3. A continuous accessible path of travel is to be provided from street frontage and vehicle parking to entry complying with AS1428.1

Letterboxes

11. Letterboxes to be on hard standing area connected to accessible path of travel.

Private car accommodation

14. Car parking space or garage min. area 6.0 m x 3.8 m post adaptation.

Accessible Entry

- 20. Accessible entry to be provided.
- 22. Accessible entry to be level (i.e. max. 1:40 slope)
- 23. Threshold to be low-level.
- 24. Landing to enable wheelchair maneuverability
- 25. Accessible entry door to have 850 mm min. clearance
- 26. Weatherproofed entry door
- 27. Door level handles and hardware to AS 1428.1.
- 28. Provision for combined door/security door

Interior

- 32. Internal doors to have 820 mm min clearance.
- 33. Internal corridors min. width of 1000 mm.
- 34. Provision for compliance with AS 1428.1 for door approaches.

Living and Dining room

- 36. Provision for circulation space of min. 2250 mm diameter
- 38. Telephone adjacent to GPO
- 41. Potential illumination level min. 300 lux.

Kitchen

- 42. Minimum width 2.7 m (1550 mm clear between benches)
- 43. Provision for circulation at doors to comply with AS 1428.1
- 45. Refrigerator adjacent to work surface
- 47. Kitchen sink bowl max. 150 mm deep
- 48. Tap set capstan or lever handles or lever mixer.
- 49. Tap set located within 300 mm of front of sink
- 51. Cooktops to include either front or side controls with raised crossbars.
- 52. Cooktops to include isolating switch.
- 59. GPOs to comply with AS 1428.1. At least one double GPO within 300 mm of front of work surface.
- 60. GPO for refrigerator to be easily reachable when the refrigerator is in operating position
- 61. Slip-resistant floor surface.
mm above floor

Bedroom

62. At least one bedroom of area sufficient to accommodate queen size bed and wardrobe and circulation space requirements of AS 1428.2

Bathroom

- 75. Provision for bathroom area to comply with AS 1428.1. 76 Slip-resistant floor surface.
- 77. Shower recess-no hob. Minimum size 1160 x 1100 to comply with AS 1428.1.
- 78. Shower area waterproofed to AS 3740 with floor to fall to waste.
- 79. Recessed soap holder.
- 80. Shower taps positioned for easy reach to access side of shower sliding track.
- 81. Shower waste min. 80 mm diameter
- 82. Provision for adjustable, detachable hand held shower rose mounted on a slider grab rail or fixed hook (plumbing and wall-strengthening provision)
- 83. Provision for grabrail in shower (Refer to Figure 4.7) to comply with AS 1428.1
- 86. Tap sets to be capstan or lever handles with single outlet.
- 88. Provision for washbasin with clearances to comply with AS 1428.1.
- 90. Double GPO beside mirror - Slip-resistant floor surface

Toilet

- 92. Provision of either 'visitable toilet' or accessible toilet.
- 93. Provision to comply with AS 1428.1
- 94. Location of WC pan at correct distance from fixed walls.
- 95. Provision for grab rail zone.
- 96. Slip resistant floor surface.

Laundry

- Provision for 1550mm circulation space in front or beside appliances
- Provision for automatic washing machine
- Where clothes line is provided, an accessible path of travel to the clothesline
- Double GPO power point.
- Slip resistant floor surface

Door locks

110. Door hardware operable with one hand, located 900-1100 mm above floor

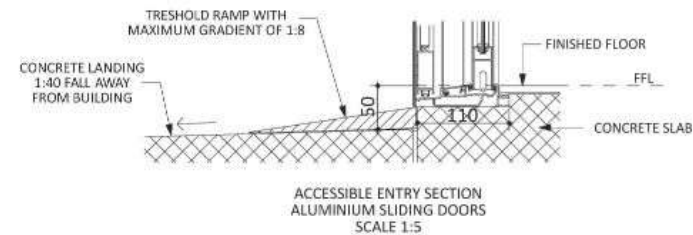
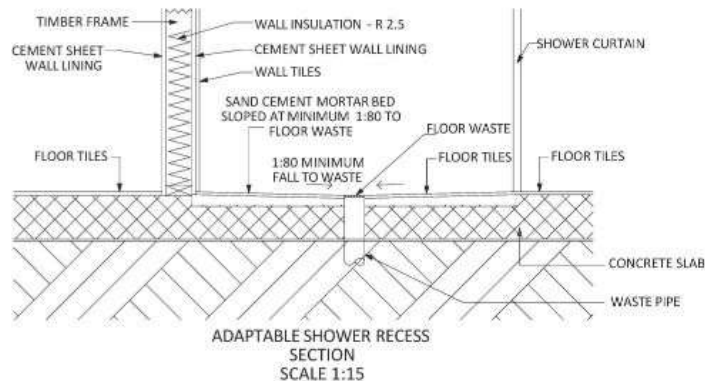
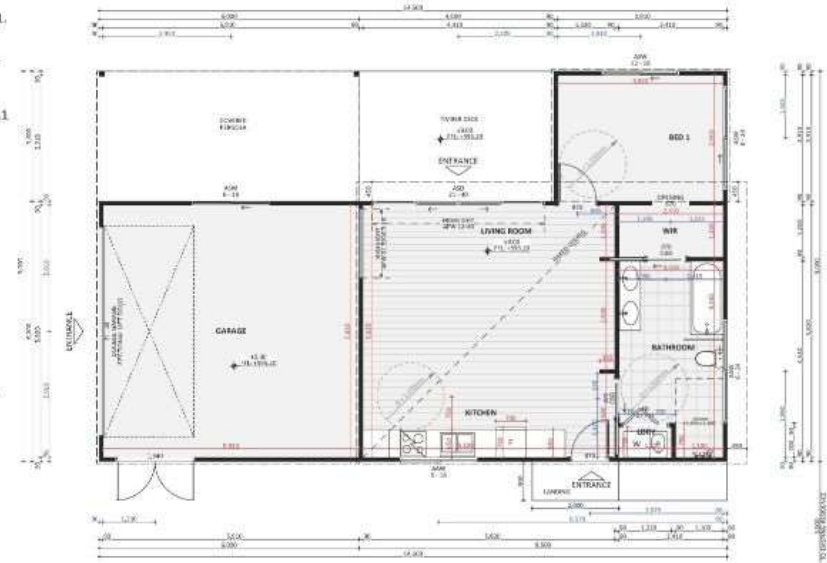

ARCHITECT INITIALS	DESIGNER	TEMPLATE	BLOCK TYPE
Z.E.	JAMIE	v.17	LARGE

AREAS	
Proposed Structure GFA - Single Storey - Class 1	63.00 m ²
Proposed Structure GFA - Class 10	26.00 m ²
Proposed Rsa ² Area - Class 1	67.83 m ²
Proposed Rsa ² Area - Class 10	36.00 m ²
Block Area	1,329.00 m²
Actual Block Ratio	26.85%
Actual PCS (GFA + Gar. GFA + Driveway) - Block area	878.70 m ²
Minimum Private Open Space (Block area x 0.60)	793.80 m ²
Site Coverage (Max 40%)	52.51%

REV	DESIGN PHASE	DATE
06.5	CONCEPT DESIGN	16-Nov-22

NAME	SIGNATURE	DATE

DRAWING NAME			
ACCESS AND MOBILITY PLAN			
DRAWING SCALE	SHEET SIZE	DRAWING NUMBER	CHECKLIST NUMBER
1:100	A3	CD-9	0850



PROJECT DETAILS			
ARCHITECT INITIALS:	DESIGNER:	TEMPLATE:	BLOCK TYPE:
Z.E.	JAMIE	v.17	LARGE

AREAS	
Proposed Structure GFA - Single Storey - Class 3	63.00 m ²
Proposed Structure GFA - Class 10	26.00 m ²
Proposed Roof Area - Class 1	67.50 m ²
Proposed Roof Area - Class 10	36.00 m ²
Block Area	1,323.00 m²
Actual Block Ratio	26.85%
Actual FGS (GFA + Gar. GFA + Driveway) - Block area	678.70 m ²
Minimum Private Open Space (Block area x 0.60)	793.80 m ²
Site Coverage (Area 478)	52.51%

REV	DESIGN PHASE	DATE
06.5	CONCEPT DESIGN	16-Nov-22

CUSTOMER APPROVAL

NAME	SIGNATURE	DATE

DRAWING NAME			
PARKING AND ACCESS PLAN			
DRAWING SCALE	SHEET SIZE	DRAWING NUMBER	CHECKLIST NUMBER
1:200	A3	CD-10	0850

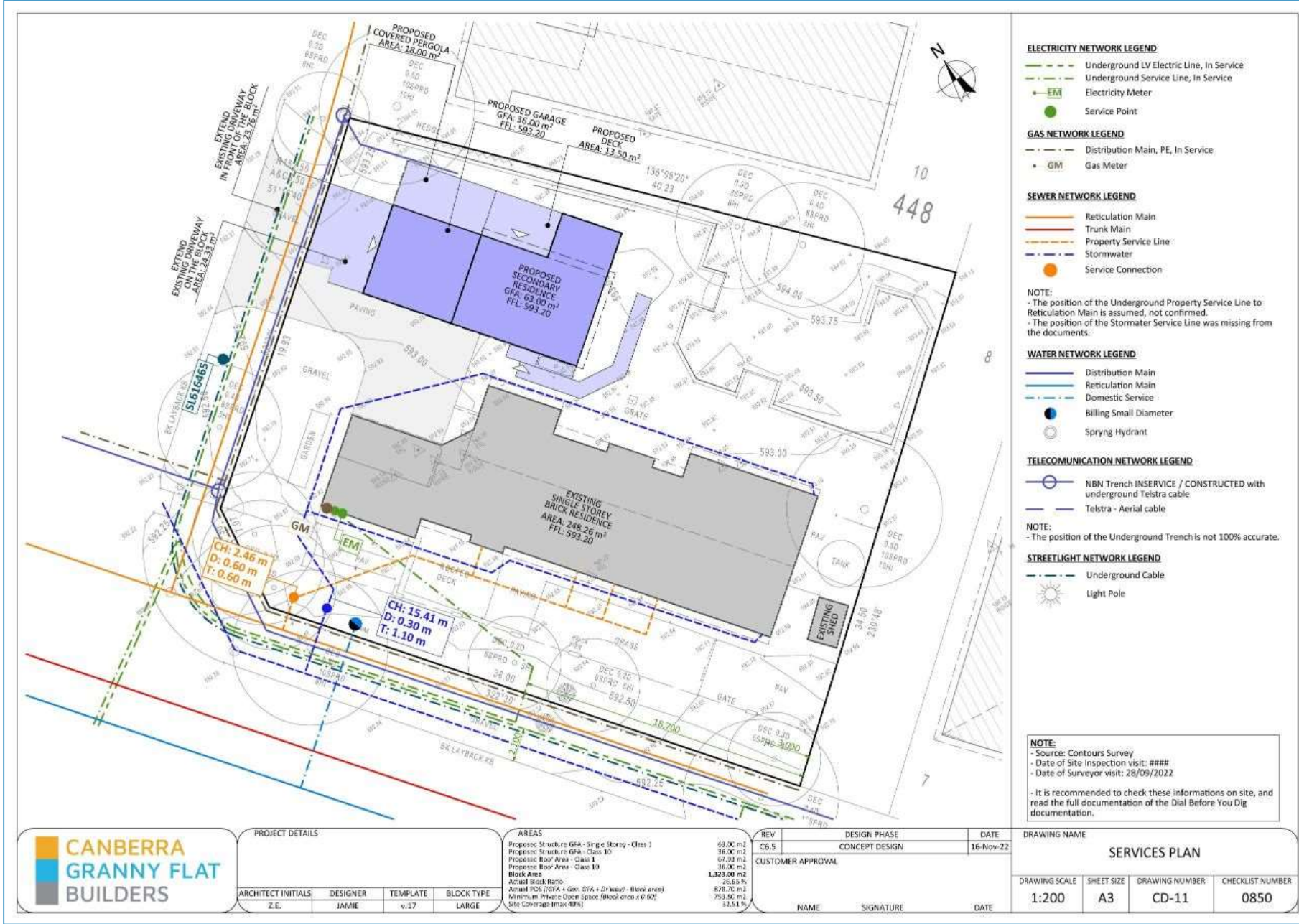

PROJECT DETAILS				AREAS	
ARCHITECT INITIALS	DESIGNER	TEMPLATE	BLOCK TYPE	Proposed Structure GFA - Single Storey - Class 1	69.00 m ²
Z.E.	JAMIE	v.17	LARGE	Proposed Structure GFA - Class 10	36.00 m ²
				Proposed Roof Area - Class 1	67.50 m ²
				Proposed Roof Area - Class 10	36.00 m ²
				Block Area	1,323.00 m²
				Actual Block Ratio	26.65 %
				Actual PCS (GFA + Gar. GFA + Driveway) - Block area	878.70 m ²
				Minimum Private Open Space (Block area x 0.60)	753.00 m ²
				Site Coverage (Max 40%)	52.51 %

REV	DESIGN PHASE	DATE
06.5	CONCEPT DESIGN	16-Nov-22

CUSTOMER APPROVAL		
NAME	SIGNATURE	DATE

DRAWING NAME			
SERVICES PLAN			
DRAWING SCALE	SHEET SIZE	DRAWING NUMBER	CHECKLIST NUMBER
1:200	A3	CD-11	0850



SECTION "A"

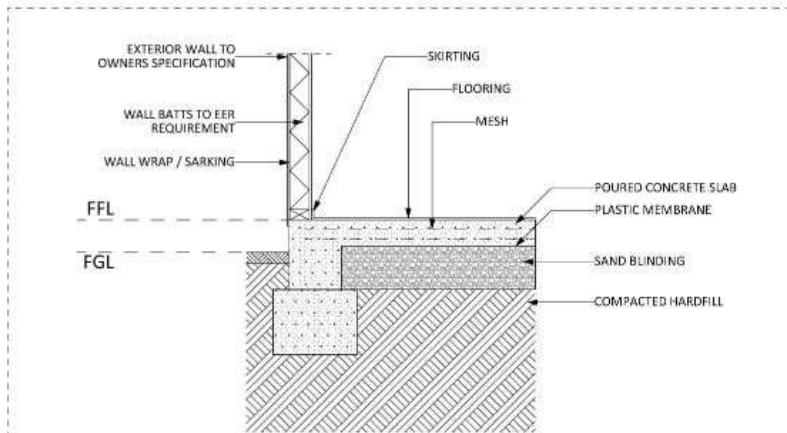

DETAIL 1 1:20

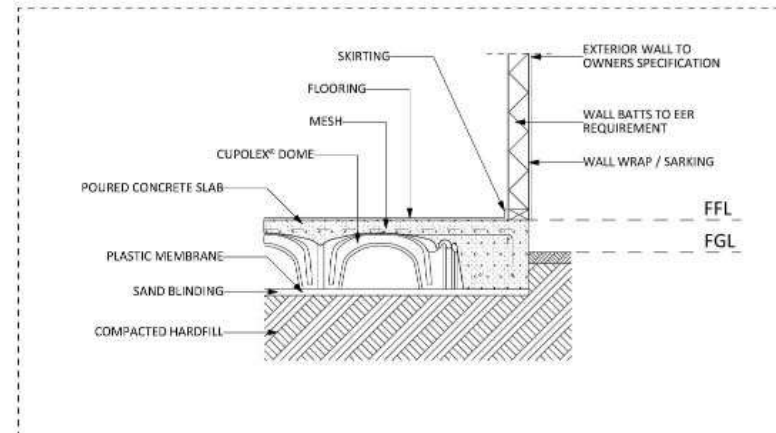

DETAIL 2 1:20



PROJECT DETAILS			
ARCHITECT INITIALS	DESIGNER	TEMPLATE	BLOCK TYPE
Z.E.	JAMIE	v.17	LARGE

AREAS	
Proposed Structure GFA - Single Storey - Class 1	69.00 m ²
Proposed Structure GFA - Class 10	36.00 m ²
Proposed Base Area - Class 1	67.50 m ²
Proposed Base Area - Class 10	36.00 m ²
Block Area	1,329.00 m²
Actual Block Ratio	26.85%
Actual PCS (GFA + Gar. GFA + Driveway) - Block area	878.70 m ²
Minimum Private Open Space (Block area x 0.60%)	753.90 m ²
Site Coverage (Max 40%)	52.51%

REV	DESIGN PHASE	DATE	DRAWING NAME
06.5	CONCEPT DESIGN	16-Nov-22	SECTION "A"

CUSTOMER APPROVAL			
NAME	SIGNATURE	DATE	DRAWING NAME
			SECTION "A"

DRAWING SCALE	SHEET SIZE	DRAWING NUMBER	CHECKLIST NUMBER
1:55, 1:20	A3	CD-12	0850

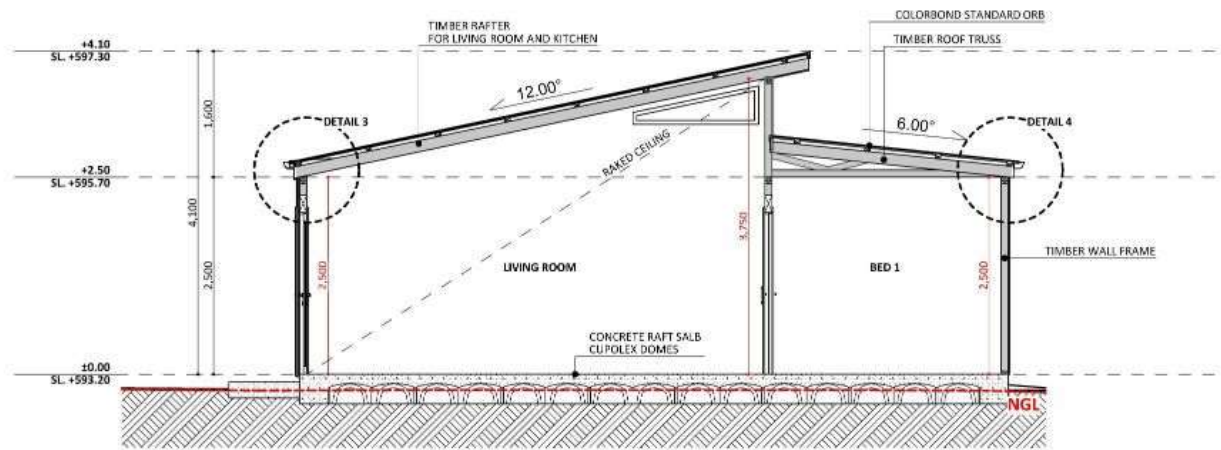

SECTION "B"

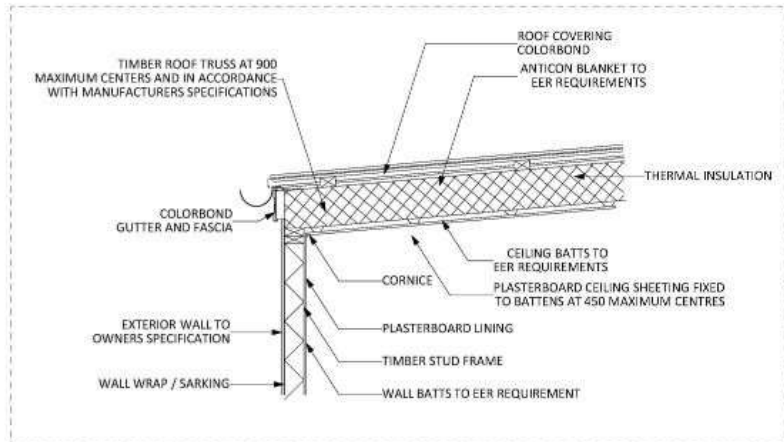

DETAIL 3 1:20

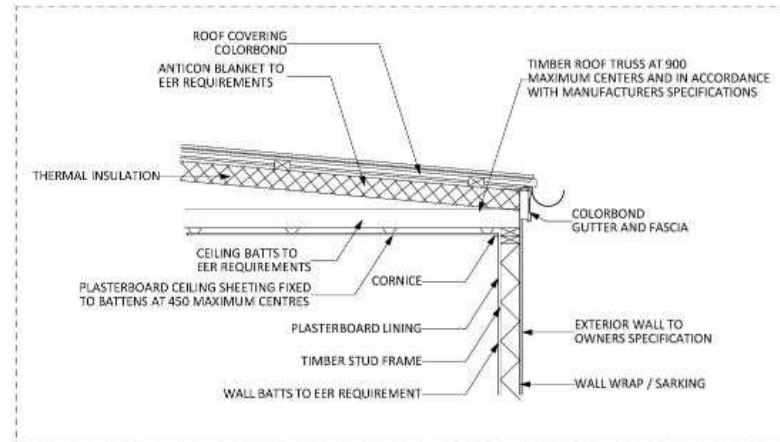

DETAIL 4 1:20



PROJECT DETAILS			
ARCHITECT INITIALS	DESIGNER	TEMPLATE	BLOCK TYPE
Z.E.	JAMIE	v.17	LARGE

AREAS	
Proposed Structure GFA - Single Storey - Class 1	69.00 m ²
Proposed Structure GFA - Class 10	36.00 m ²
Proposed Roof Area - Class 1	67.93 m ²
Proposed Roof Area - Class 10	36.00 m ²
Block Area	1,329.00 m²
Actual Block Ratio	26.85 %
Actual PCS (GFA + Gar. GFA + Driveway) - Block area	878.70 m ²
Minimum Private Open Space (Block area x 0.60)	753.80 m ²
Site Coverage (Max 40%)	52.51 %

REV	DESIGN PHASE	DATE	DRAWING NAME
C6.5	CONCEPT DESIGN	16-Nov-22	SECTION "B"

CUSTOMER APPROVAL			
NAME	SIGNATURE	DATE	DRAWING NAME
			SECTION "B"

DRAWING SCALE	SHEET SIZE	DRAWING NUMBER	CHECKLIST NUMBER
1:55, 1:20	A3	CD-13	0850



NOTES:

- Front Zone**
- The Front Zone is usually the area between the Front Boundary and the Building Line. The Building Line can be determined using the rule below
 - If the minimum setback requirement is greater than the distance to the building line, then it is this distance that will determine the Front Zone. This is rare. Typically, the minimum setback from the front boundary is 6m
 - The Front Zone can also not have a length greater than 10 metres into the block. Again this is rare.
- Building Line**
- This is a line drawn parallel to the front boundary along the front face of a building, or trough the point on the building which is closest to the front boundary.
 - A terrace, landing, porch, balcony, deck or verandah that is more than 1.5 metres above finished ground level or is covered by a roof is deemed to be part of the building. A fence, courtyard wall or retaining wall is not deemed to be part of the building.
- Primary Building Zone**
- The area between the front zone and a line projected 12 metres from this zone.
- Rear zone**
- The area of the block behind the Primary Building Zone
- Perpendicular line from boundaries**
- A line drawn at a right angle (90 degrees) from the boundary
 - This does not need to be completed if there is no adjoining residential block
- Line with a bearing of North**
- A line drawn that goes directly North
 - This should be drawn from the same point that the Perpendicular line from the Boundary is drawn
 - This does not need to be completed if there is no adjoining residential block
- Angle between the Line with a Bearing of North and Perpendicular Line from Boundary**
- The angle measured between these two lines
 - This angle should always be less than 180 degrees

LEGEND

SYMBOL	DESCRIPTION
	BUILDING LINE
	PLOT PROFILE LINE FOR SOLAR AND BUILDING ENVELOPE, PERPENDICULAR TO THE RELEVANT BOUNDARY LINE
	FRONT ZONE
	PRIMARY BUILDING ZONE
	REAR ZONE
	LINE WITH A BEARING OF NORTH TO ESTABLISH SOLAR BOUNDARY ENVELOPE



ARCHITECT INITIALS	DESIGNER	TEMPLATE	BLOCK TYPE
Z.E.	JAMIE	v.17	LARGE

AREAS	AREA
Proposed Structure GFA - Single Storey - Class 3	63.00 m ²
Proposed Structure GFA - Class 10	26.00 m ²
Proposed Roof Area - Class 1	57.50 m ²
Proposed Roof Area - Class 10	36.00 m ²
Block Area	1,323.00 m²
Actual Block Ratio	26.85%
Actual FOS (GFA + Gar. GFA + Driveway) - Block area	578.70 m ²
Minimum Private Open Space (Block area x 0.60)	793.30 m ²
Site Coverage (Max 40%)	52.51%

REV	DESIGN PHASE	DATE
06.5	CONCEPT DESIGN	16-Nov-22

CUSTOMER APPROVAL

NAME	SIGNATURE	DATE

DRAWING NAME			
BUILDING ZONE			
DRAWING SCALE	SHEET SIZE	DRAWING NUMBER	CHECKLIST NUMBER
1:200	A3	CD-14	0850

NOTES:
BUILDING ENVELOPE

- ▶ **Large Blocks** (Greater than 500m²)
 - This rule applies to side and rear boundaries
 - Building Envelope Fence Height - 3.5 m
 - Angle of projection from Building Envelope Fence - 45 Degrees
 - ▶ **Mid-Sized Blocks Approved after 5 July 2013** (250 m² to 500m²)
 - This rule applies to side and rear boundaries
 - Building Envelope Fence Height - 3.5 m
 - Angle of projection from Building Envelope Fence - 45 Degrees
 - ▶ **Mid-Sized Blocks Approved before 5 July 2013** (250 m² to 500m²)
 - For North Facing Boundaries of Adjoining Residential Blocks (see below definition)
 - Building Envelope Fence Height
 - Primary Building Zone - 2m
 - Rear Zone - 2m
 - Angle of Projection from Building Envelope Fence
 - Primary Building Zone - 45 Degrees
 - Rear Zone - 30 Degrees
 - Note: if we are building on the boundary there can be different rules. Consult with Planning Approvals Manager
 - For all other boundaries of adjoining residential blocks
 - Building Envelope Fence Height
 - Primary Building Zone - 4.5m
 - Rear Zone - 3.5m
 - Angle of Projection from Building Envelope Fence
 - Primary Building Zone - 45 Degrees
 - Rear Zone - 30 Degrees
- For this rule: North Facing Boundary means a boundary of a block where a line drawn perpendicular to the boundary outwards is orientated between 30 degrees east of north and 20 degrees west of north. This is only for Mid-Sized Blocks Approved before the 5 July 2013

SOLAR BUILDING ENVELOPE

- ▶ **Large Blocks if Approved before 5 July 2013**
 - The Solar Building Envelope Rule applies to any Northern Boundary of an adjoining residential block.
 - Height of the Solar Fence is:
 - In the Front and Primary Building Zone - 2.4m
 - On all other parts of the boundary - 1.8m
- ▶ **All Blocks if Approved after 5 July 2013**
 - The Solar Building Envelope Rule applies to any Northern Boundary of an adjoining residential block.
 - Height of the Solar Fence is:
 - In the Front and Primary Building Zone - 3m
 - On all other parts of the boundary - 2.3m

Table 1 – Apparent sun angle (X) at noon on the winter solstice (21 June)

Aspect of northern boundary (bearing of line drawn perpendicular to the boundary)	Angle (X)
North 0° to <10° East	31°
North 0° to <10° West	31°
North 10° to <20° East	32°
North 10° to <20° West	32°
North 20° to <30° East	34°
North 20° to <30° West	34°
North 30° to <40° East	36°
North 30° to <40° West	36°
North 40° to <45° East	39°
North 40° to <45° West	39°

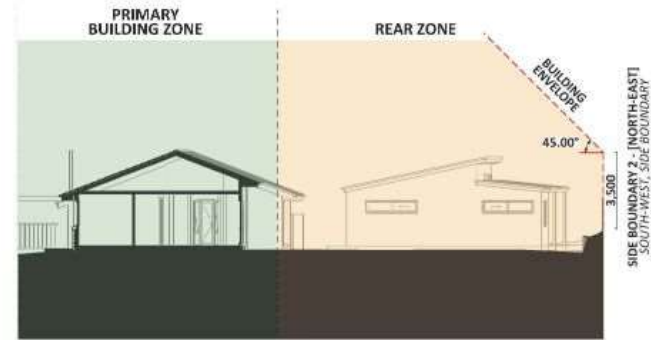

S1 BLOCK PROFILE



S2 BLOCK PROFILE



ARCHITECT INITIALS: Z.E.	DESIGNER: JAMIE	TEMPLATE: v.17	BLOCK TYPE: LARGE
-----------------------------	--------------------	-------------------	----------------------

AREAS	
Proposed Structure GFA - Single Storey - Class 1	63.00 m ²
Proposed Structure GFA - Class 10	26.00 m ²
Proposed Roof Area - Class 1	67.50 m ²
Proposed Roof Area - Class 10	36.00 m ²
Block Area	1,323.00 m²
Actual Block Ratio	26.85%
Actual FCS (GFA + Gar. GFA + Driveway) - Block area	878.70 m ²
Minimum Private Open Space /Block area x 0.60%	793.90 m ²
Site Coverage (Max 40%)	52.51%

REV	DESIGN PHASE	DATE
06.5	CONCEPT DESIGN	16-Nov-22

CUSTOMER APPROVAL

NAME	SIGNATURE	DATE

DRAWING NAME			
SOLAR AND BUILDING ENVELOPE			
DRAWING SCALE	SHEET SIZE	DRAWING NUMBER	CHECKLIST NUMBER
1:200	A3	CD-16	0850

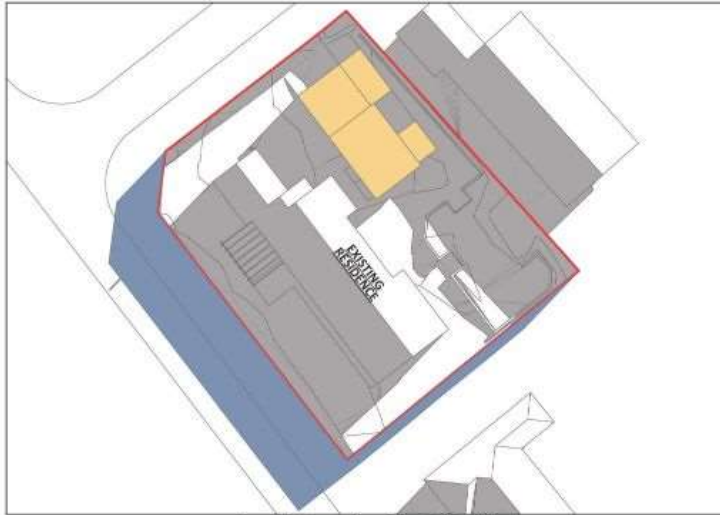

Sun-Winter - Jun 21 - 9:00 AM

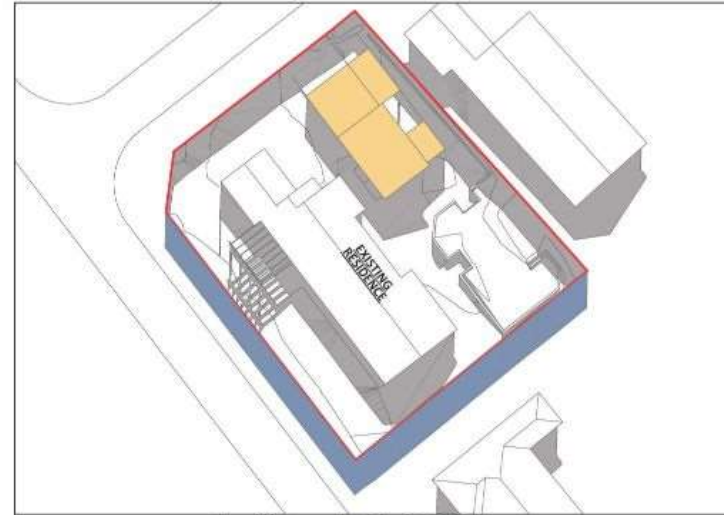

Sun-Winter - Jun 21 - 12:00 PM noon

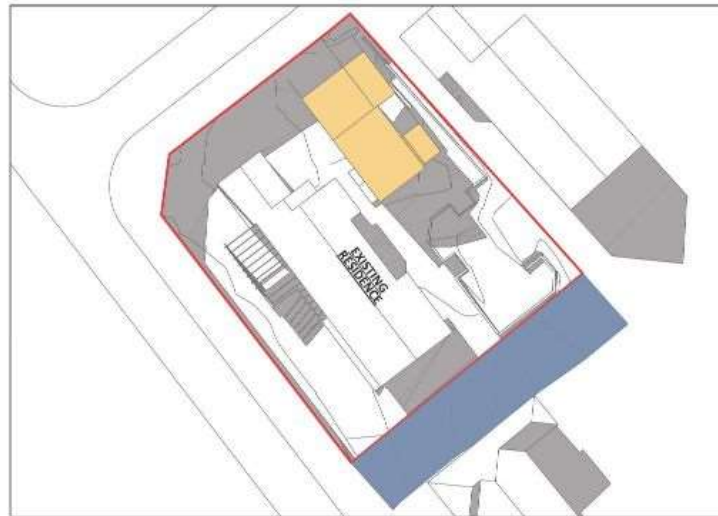

Sun-Winter - Jun 21 - 3:00 PM

LEGEND:

- THE ROOF AREA OF THE PROPOSED STRUCTURE. IN THE CASE OF AN ATTACHED EXTENSION, THE NEW ROOF CAN OVERLAP WITH THE EXISTING ROOF
- SHADOW OF THE EXISTING STRUCTURES IN THE AREA, AND ON THE CLIENTS BLOCK
- SHADOW OF A 2.40M HIGH SOLAR FENCE, CAST OUTSIDE OF THE CLIENTS BLOCK
- SHADOW OF EXISTING STRUCTURES, CAST OUTSIDE OF CLIENT'S BLOCK



PROJECT DETAILS			
ARCHITECT INITIALS:	DESIGNER	TEMPLATE	BLOCK TYPE
Z.E.	JAMIE	v.17	LARGE

AREAS	
Proposed Structure GFA - Single Storey - Class 3	63.00 m ²
Proposed Structure GFA - Class 10	26.00 m ²
Proposed Roof Area - Class 1	67.23 m ²
Proposed Roof Area - Class 10	36.00 m ²
Block Area	1,323.00 m²
Actual Block Ratio	26.85%
Actual FGS (GFA + Gar. GFA + Driveway) - Block area	878.70 m ²
Minimum Private Open Space (Block area x 0.60)	793.80 m ²
Site Coverage (max 40%)	52.51%

REV	DESIGN PHASE	DATE
06.5	CONCEPT DESIGN	16-Nov-22

CUSTOMER APPROVAL		
NAME	SIGNATURE	DATE

DRAWING NAME			
SHADOW DIAGRAM - WINTER			
DRAWING SCALE	SHEET SIZE	DRAWING NUMBER	CHECKLIST NUMBER
	A3	CD-17	0850

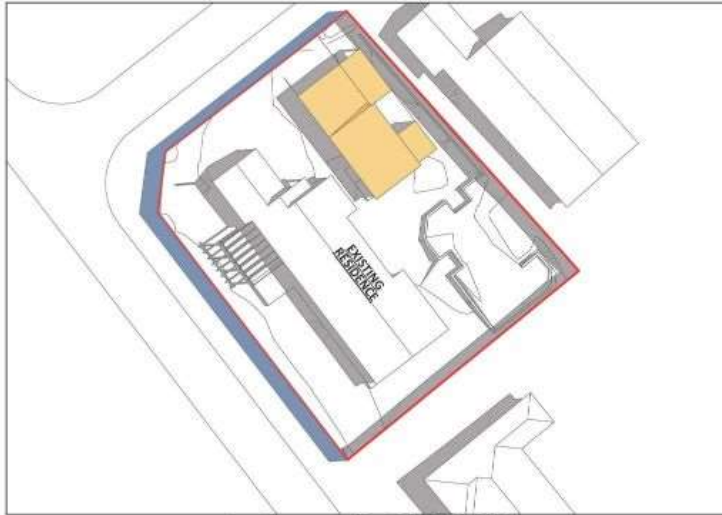

Sun-Summer - Dec 21 - 9:00 AM

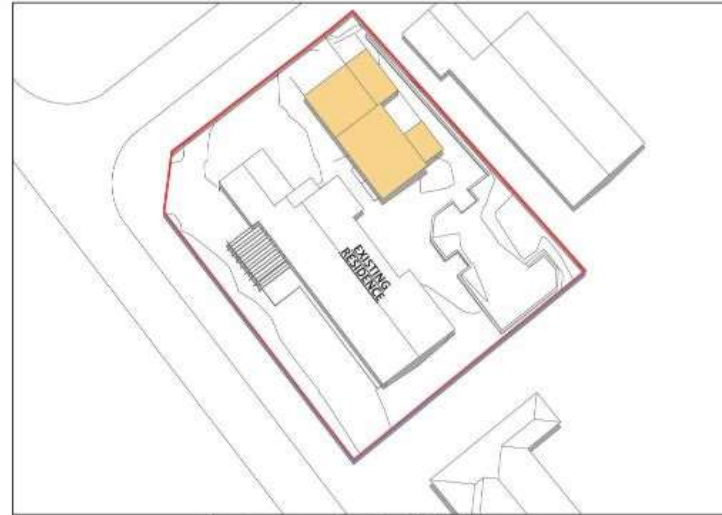

Sun-Summer - Dec 21 - 12:00 PM noon

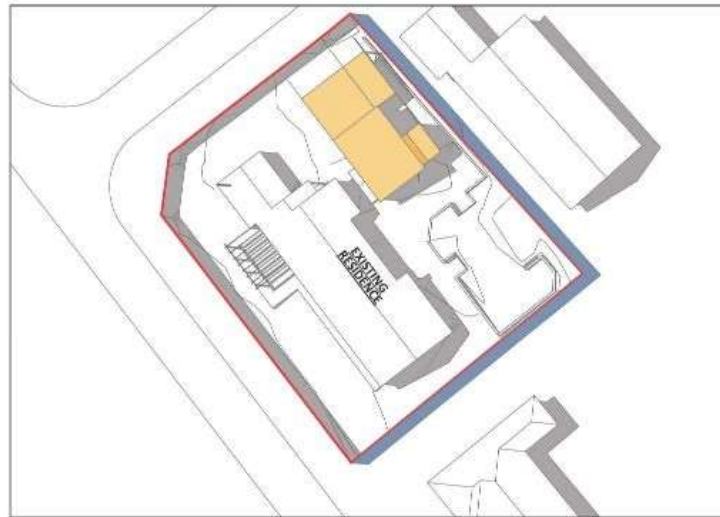

Sun-Summer - Dec 21 - 3:00 PM

LEGEND:

- THE ROOF AREA OF THE PROPOSED STRUCTURE. IN THE CASE OF AN ATTACHED EXTENSION, THE NEW ROOF CAN OVERLAP WITH THE EXISTING ROOF
- SHADOW OF THE EXISTING STRUCTURES IN THE AREA, AND ON THE CLIENTS BLOCK
- SHADOW OF A 2.40M HIGH SOLAR FENCE, CAST OUTSIDE OF THE CLIENTS BLOCK
- SHADOW OF EXISTING STRUCTURES, CAST OUTSIDE OF CLIENT'S BLOCK



PROJECT DETAILS			
ARCHITECT INITIALS:	DESIGNER	TEMPLATE	BLOCK TYPE
Z.E.	JAMIE	v.17	LARGE

AREAS	
Proposed Structure GFA - Single Storey - Class 3	63.00 m ²
Proposed Structure GFA - Class 10	26.00 m ²
Proposed Roof Area - Class 1	67.50 m ²
Proposed Roof Area - Class 10	36.00 m ²
Block Area	1,323.00 m²
Actual Block Ratio	26.85%
Actual FOS (GFA + Gar. GFA + Driveway) - Block area	878.70 m ²
Minimum Private Open Space /Block area x 0.60*	793.80 m ²
Site Coverage (max 40%)	52.51%

REV	DESIGN PHASE	DATE
06.5	CONCEPT DESIGN	16-Nov-22

CUSTOMER APPROVAL		
NAME	SIGNATURE	DATE

DRAWING NAME			
SHADOW DIAGRAM - SUMMER			
DRAWING SCALE	SHEET SIZE	DRAWING NUMBER	CHECKLIST NUMBER
	A3	CD-18	0850



- CONDITIONS:**
- Protected trees shall be fenced off by a continuous 1800 mm high chain wire fence.
 - Demolition work, excavation for roots within the tree protection zone shall be undertaken by hand, and any roots uncovered with a diameter greater than 50mm are to be bridged over.
 - The fence shall be erected prior to the commencement of any construction works on any part/stage of the development and is to remain in place until construction works are completed.
 - Construction of a low impact footings to any part of the residence within the tree protection zone, a low impact footing does not cut into the root system, except for isolated piers.
 - No work, that includes but is not limited to, excavation (e. g. for services including gas, water, sewer, stormwater, electricity, telecommunications, footings and irrigation) or modifications of exist ground levels is - to occur within the fenced area/tree protection zone.
 - Services that need to be installed within the fenced area/tree protection zone of the tree shall be under bored unless otherwise approved in writing by the Conservator.
 - If root pruning/removal is required, roots shall be cut cleanly (not pulled, torn or ripped).
 - Exposed roots shall be kept damp and backfilled as soon as possible.
 - It is recommended that mulching and irrigation within the Tree Protection Zone must be undertaken during the period of development to sustain the tree, particularly over the summer months.

LEGEND

- Trees to be removed on the block
- Trees to be retained and maintained on the block
- Existing Structures in the vicinity
- Existing Structures on studied block
- Existing Footpath, Driveway, Deck on the block
- Proposed Structure
- Proposed Deck, Stairs, Alfresco, Paths, Water Tank and Driveway
- Protection area
- Tree Protection Fence
- Property Boundary



PROJECT DETAILS				AREAS	
ARCHITECT INITIALS:	DESIGNER:	TEMPLATE:	BLOCK TYPE:	Proposed Structure GFA - Single Storey - Class 3	63.00 m ²
Z.E.	JAMIE	v.17	LARGE	Proposed Structure GFA - Class 10	26.00 m ²
				Proposed Roof Area - Class 1	57.50 m ²
				Proposed Roof Area - Class 10	36.00 m ²
				Block Area	1,323.00 m²
				Actual Block Ratio	26.85%
				Actual PCS (GFA + Gar. GFA + Driveway) - Block area	578.70 m ²
				Minimum Private Open Space (Block area x 0.60)	793.92 m ²
				Site Coverage (Max 40%)	52.51%

REV	DESIGN PHASE	DATE
06.5	CONCEPT DESIGN	16-Nov-22

CUSTOMER APPROVAL

NAME	SIGNATURE	DATE

DRAWING NAME			
TREE MANAGEMENT			
DRAWING SCALE	SHEET SIZE	DRAWING NUMBER	CHECKLIST NUMBER
1:200	A3	CD-19	0850



- SITE PLAN LEGEND:**
- Studied Block property line
 - Other Property lines and elements
 - Trees
 - Entrance of Existing structures
 - Existing Structures in the vicinity
 - Existing Structures on studied block
 - Proposed Structure
 - Proposed Deck, Stairs, Alfresco, Paths, Water Tank and Driveway

- TREE PLANTING**
- Small Tree
Height: 5-8m / Min. Canopy: 4m
 - Medium Tree
Height: 8-12m / Min. Canopy: 6m
 - Large Tree
Height: >12m / Min. Canopy: 8m
 - Deep Soil Zones

Block Type	Minimum tree requirement
LARGE, > 800 m ²	one small and one medium, plus one large or two medium for each additional 800 m ²
LARGE, <= 800 m ²	one small and one medium
MID-SIZED	two small
COMPACT	one small

- EASEMENT LEGEND:**
- Easement maintenance access
 - Stormwater easement
 - Sewer easement
 - Electrical easement
 - Stormwater and Electrical easement
 - Sewer and Electrical easement
 - Stormwater and Sewer easement
 - Gas easement
 - Right of Way easement
 - Telecommunications easement
 - Water easement

NOTE:
 - Block Type: LARGE
 - Source: Contours Survey
 - Date of Surveyor visit: 28/09/2022



PROJECT DETAILS				AREAS	
ARCHITECT INITIALS:	DESIGNER:	TEMPLATE:	BLOCK TYPE:	Proposed Structure GFA - Single Storey - Class 3	63.00 m ²
Z.E.	JAMIE	v.17	LARGE	Proposed Structure GFA - Class 10	26.00 m ²
				Proposed Roof Area - Class 1	57.50 m ²
				Proposed Roof Area - Class 10	36.00 m ²
				Block Area	1,323.00 m²
				Actual Block Ratio	26.85%
				Actual PCS (GFA + Gar. GFA + Driveway) - Block area	578.70 m ²
				Minimum Private Open Space (Block area x 0.60)	793.92 m ²
				Site Coverage (Max 40%)	52.51%

REV	DESIGN PHASE	DATE
06.5	CONCEPT DESIGN	16-Nov-22

CUSTOMER APPROVAL

NAME	SIGNATURE	DATE

DRAWING NAME			
LIVING INFRASTRUCTURE PLAN			
DRAWING SCALE	SHEET SIZE	DRAWING NUMBER	CHECKLIST NUMBER
1:200	A3	CD-20	0850



PROJECT DETAILS				AREAS	
ARCHITECT INITIALS	DESIGNER	TEMPLATE	BLOCK TYPE	Proposed Structure GFA - Single Storey - Class 1	69.00 m ²
Z.E.	JAMIE	v.17	LARGE	Proposed Structure GFA - Class 10	36.00 m ²
				Proposed Structure GFA - Class 30	67.50 m ²
				Proposed Roof Area - Class 1	36.00 m ²
				Proposed Roof Area - Class 10	36.00 m ²
				Block Area	1,323.00 m²
				Actual Block Ratio	26.85 %
				Actual PCS (GFA + Gar. GFA + Driveway) - Block area	878.70 m ²
				Minimum Private Open Space (Block area x 0.60)	793.80 m ²
				Site Coverage (Max 40%)	52.51 %

REV	DESIGN PHASE	DATE
C6.5	CONCEPT DESIGN	16-Nov-22

CUSTOMER APPROVAL		
NAME	SIGNATURE	DATE

DRAWING NAME			
SNAPSHOT 1			
DRAWING SCALE	SHEET SIZE	DRAWING NUMBER	CHECKLIST NUMBER
	A3	CD-21	0850



ARCHITECT INITIALS	DESIGNER	TEMPLATE	BLOCK TYPE
Z.E.	JAMIE	v.17	LARGE

AREAS	
Proposed Structure GFA - Single Storey - Class 1	69.00 m ²
Proposed Structure GFA - Class 10	36.00 m ²
Proposed Roof Area - Class 1	67.53 m ²
Proposed Roof Area - Class 10	36.00 m ²
Block Area	1,328.00 m²
Actual Block Ratio	26.85 %
Actual PCS (GFA + Gar. GFA + Driveway) - Block area	878.70 m ²
Minimum Private Open Space (Block area x 0.60)	793.80 m ²
Site Coverage (Max 40%)	52.51 %

REV	DESIGN PHASE	DATE
06.5	CONCEPT DESIGN	16-Nov-22

CUSTOMER APPROVAL

NAME	SIGNATURE	DATE

DRAWING NAME			
SNAPSHOT 2			
DRAWING SCALE	SHEET SIZE	DRAWING NUMBER	CHECKLIST NUMBER
	A3	CD-22	0850



PROJECT DETAILS			
ARCHITECT INITIALS	DESIGNER	TEMPLATE	BLOCK TYPE
Z.E.	JAMIE	v.17	LARGE

AREAS	
Proposed Structure GFA - Single Storey - Class 1	69.00 m ²
Proposed Structure GFA - Class 10	36.00 m ²
Proposed Roof Area - Class 1	67.53 m ²
Proposed Roof Area - Class 10	36.00 m ²
Block Area	1,329.00 m²
Actual Block Ratio	26.85 %
Actual PCS (GFA + Gar. GFA + Driveway) - Block area	878.70 m ²
Minimum Private Open Space (Block area x 0.60)	797.40 m ²
Site Coverage (max 40%)	52.51 %

REV	DESIGN PHASE	DATE
C6.5	CONCEPT DESIGN	16-Nov-22

CUSTOMER APPROVAL

NAME	SIGNATURE	DATE

DRAWING NAME			
SNAPSHOT 3			
DRAWING SCALE	SHEET SIZE	DRAWING NUMBER	CHECKLIST NUMBER
	A3	CD-23	0850



PROJECT DETAILS			
ARCHITECT INITIALS	DESIGNER	TEMPLATE	BLOCK TYPE
Z.E.	JAMIE	v.17	LARGE

AREAS	
Proposed Structure GFA - Single Storey - Class 1	69.00 m ²
Proposed Structure GFA - Class 10	36.00 m ²
Proposed Roof Area - Class 1	67.50 m ²
Proposed Roof Area - Class 10	36.00 m ²
Block Area	1,329.00 m²
Actual Block Ratio	26.85 %
Actual PCS (GFA + Gar. GFA + Driveway) - Block area	878.70 m ²
Minimum Private Open Space (Block area x 0.60)	797.40 m ²
Site Coverage (Max 40%)	52.51 %

REV	DESIGN PHASE	DATE
C6.5	CONCEPT DESIGN	16-Nov-22

CUSTOMER APPROVAL		
NAME	SIGNATURE	DATE

DRAWING NAME			
SNAPSHOT 4			
DRAWING SCALE	SHEET SIZE	DRAWING NUMBER	CHECKLIST NUMBER
	A3	CD-24	0850



PROJECT DETAILS			
ARCHITECT INITIALS	DESIGNER	TEMPLATE	BLOCK TYPE
Z.E.	JAMIE	v.17	LARGE

AREAS	
Proposed Structure GFA - Single Storey - Class 1	69.00 m ²
Proposed Structure GFA - Class 30	36.00 m ²
Proposed Roof Area - Class 1	67.53 m ²
Proposed Roof Area - Class 30	36.00 m ²
Block Area	1,329.00 m²
Actual Block Ratio	26.85 %
Actual FOS (GFA + Gar. GFA + Driveway) - Block area	878.70 m ²
Minimum Private Open Space (Block area < 6.00)	753.90 m ²
Site Coverage (Max 40%)	52.51 %

REV	DESIGN PHASE	DATE
C6.5	CONCEPT DESIGN	16-Nov-22

CUSTOMER APPROVAL		
NAME	SIGNATURE	DATE

DRAWING NAME			
SNAPSHOT 5			
DRAWING SCALE	SHEET SIZE	DRAWING NUMBER	CHECKLIST NUMBER
	A3	CD-25	0850



PROJECT DETAILS			
ARCHITECT INITIALS	DESIGNER	TEMPLATE	BLOCK TYPE
Z.E.	JAMIE	v.17	LARGE

AREAS	
Proposed Structure GFA - Single Storey - Class 1	69.00 m ²
Proposed Structure GFA - Class 10	36.00 m ²
Proposed Roof Area - Class 1	67.53 m ²
Proposed Roof Area - Class 10	36.00 m ²
Block Area	1,328.00 m²
Actual Block Ratio	26.85 %
Actual FOS (GFA + Gar. GFA + Driveway) - Block area	878.70 m ²
Minimum Private Open Space (Block area < 6.00)	753.00 m ²
Site Coverage (Max 40%)	52.51 %

REV	DESIGN PHASE	DATE
C6.5	CONCEPT DESIGN	16-Nov-22

CUSTOMER APPROVAL		
NAME	SIGNATURE	DATE

DRAWING NAME			
3D FLOOR PLAN - VIEW 1			
DRAWING SCALE	SHEET SIZE	DRAWING NUMBER	CHECKLIST NUMBER
	A3	CD-26	0850

What happens next?

We would encourage you to enter a design agreement to either create your own custom design or modify an existing design.

This is the next step in the process, to work with our design team to create a world class design which will lead to a project proposal with a full inclusions list and fixed price project proposal and site works report.

Within the next 7 days we will email you a copy of the design agreement in softcopy and via DocuSign. That design agreement all the detail in the design process.

We will send you a word copy of our meeting minutes with screenshots and notes – if the meeting was held online or in our office. Please note that these notes from the meeting minutes are my interpretations of the details of our meeting and can easily be amended if I have missed something.

If you have additional questions or need assistance, please just call or email – details provided below. We can also have a follow-up zoom or teams meeting if you would like.

We have also put together some helpful links on our primary websites cgfb.com.au and fixedpriceextensions.com.au

- Design gallery for Secondary Residences: [Link](#)
- Design gallery for Fixed Price Extensions: [Link](#)
- Project Walkthrough videos Secondary Residences: [Link](#)
- Project Walkthrough videos Fixed Price Extensions: [Link](#)
- Project Walkthrough videos Custom Designs: [Link](#)
- Customer testimonials: [Link](#)
- The Process: [Link](#)
- Frequently Asked Questions: [Link](#)
- Our inclusions guide: [Link](#)
- Link to google reviews: [Link](#)

On a quarterly basis we do hold display homes and we would encourage you to attend one of these.

Last year we helped over 60 Canberra families with their home extension and Secondary Residence projects we would love to assist you in design, planning approvals and building of your residential project.

Thank you for taking the time out to read this report.



Frank Walmsley
Director and Client Service Manager
Mobile 0400446605
Email: clientservices@cgfb.com.au

